

2-14-2014

Evaluation of Moisture, Suction Effects and Durability Performance of Lime Stabilized Clayey Subgrade Soils

Md Tahmidur Rahman

Follow this and additional works at: https://digitalrepository.unm.edu/ce_etds

Recommended Citation

Rahman, Md Tahmidur. "Evaluation of Moisture, Suction Effects and Durability Performance of Lime Stabilized Clayey Subgrade Soils." (2014). https://digitalrepository.unm.edu/ce_etds/90

This Thesis is brought to you for free and open access by the Engineering ETDs at UNM Digital Repository. It has been accepted for inclusion in Civil Engineering ETDs by an authorized administrator of UNM Digital Repository. For more information, please contact disc@unm.edu.

Md Tahmidur Rahman

Candidate

Civil Engineering

Department

This thesis is approved, and it is acceptable in quality and form for publication:

Approved by the Thesis Committee:

Dr. Rafiqul A. Tarefder, Chairperson

Dr. Tang-Tat Ng

Dr. Arup K. Maji

**EVALUATION OF MOISTURE, SUCTION EFFECTS AND
DURABILITY PERFORMANCE OF LIME STABILIZED
CLAYEY SUBGRADE SOILS**

by

MD TAHMIDUR RAHMAN

THESIS

Submitted in Partial Fulfillment of the
Requirements for the Degree of

**Master of Science
Civil Engineering**

The University of New Mexico
Albuquerque, New Mexico

November 2013

ACKNOWLEDGEMENTS

I wish to express my deepest gratitude and appreciation to my advisor and the chair of my thesis committee, Dr. Rafiqul Tarefder, for providing me the opportunity to conduct this study. I also would like to thank the members of my committee, Dr. Tang-Tat Ng and Dr. Arup K. Maji for their valuable time.

I would like to acknowledge the New Mexico Department of Transportation Research Bureau for project funding and equipment used in this study. I specifically would like to express my thankfulness to the members of my project technical panel: Mr. Virgil Valdez, Mr. Jeff Mann, Mr. Robert McCoy, Mr. Parveez Anwar, Mr. Bob Meyers, and Mr. Bryce Simons.

I must give credit to Dr. John Stormont to guide me in the area of unsaturated soil mechanics. I appreciate the continuous supports of Mekdim Weldegiorgis and Anthony Sebastian Cabrera in laboratory and project works. Participation of Shahidul Faisal and Naomi Waterman in my lab works is greatly acknowledged. I also like to thank all my research group members for their inspiration.

Last but not the least, I would like to express thank to my wife Sanjida Ahsan for her understanding and continuous encouragement during this work. I want to express my sincere gratitude to my parents for their support and dedication in every step of my life.

EVALUATION OF MOISTURE, SUCTION EFFECTS AND DURABILITY PERFORMANCE OF LIME STABILIZED CLAYEY SUBGRADE SOILS

by **Md Tahmidur Rahman**

B.Sc. Civil Engineering, Bangladesh University of Engineering & Technology, 2009
M.S. Civil Engineering, University of New Mexico, 2013

ABSTRACT

Resilient modulus (M_R) of soils is well-accepted and essential parameter for structural design of flexible pavements using the Mechanistic Empirical Pavement Design Guide (MEPDG). A comprehensive laboratory study is undertaken to evaluate the moisture, suction effects and durability performance on resilient modulus (M_R) and unconfined compressive strength (UCS) of lime treated clayey subgrade soils. Two subgrade soils: the AASHTO class A-6 and A-7-6 are collected from US 491 road site in New Mexico. Cylindrical soil specimens are prepared according to NCHRP 1-28A at three lime percentages: 0%, 5% and 7% which are selected based on pH test. M_R tests on lime treated soils are conducted with a modified stress sequence incorporated in the AASHTO T 307 procedure based on past literature and laboratory experience gained in this study. However, M_R test is performed on the untreated soils following the AASHTO T 307 stress sequences for subgrade soils.

Test samples are prepared at three different molding moisture contents: optimum moisture content (OMC), dry state (OMC-2%) and wet state (OMC+2%). It is shown that the effects of moisture on M_R and UCS values of lime treated soils are less than those on untreated soils. Test results reveal that M_R and UCS values increase due to lime treatment depending on soil type and lime dose.

A filter paper method is used to directly determine the total and matric suctions of soils at different moisture states in this study. It is observed that all suction components (total, matric and osmotic) increase due to lime addition on untreated subgrade soils. Test results show approximately 15% increase of osmotic suction proportion to total suction after lime treatment to untreated soils. Finally, an existing M_R constitutive model is revised by incorporating total suction. The revised model is shown to have better predictive capability over existing traditional stress-dependent resilient modulus models.

For durability study, samples are prepared at optimum water content and tested after subjected to 10 and 20 freeze-thaw (F-T) cycles in a controlled environmental chamber. M_R and UCS results of F-T samples are compared with no F-T damage samples. It is seen that resilient modulus values of untreated soils reduces significantly (>80%) after 20 F-T cycles. Lime stabilization shows less than 35% reduction in M_R values due to F-T action, thus exhibit less damage than untreated soils. In addition, field saturation state is simulated in the laboratory to observe the worst wetting condition of a pavement during the service life. Untreated soaked samples collapse completely; whereas lime stabilized soils maintain integrity with no significant change in modulus values due to soaking.

TABLE OF CONTENTS

ACKNOWLEDGEMENTS	iii
ABSTRACT	iv
LIST OF FIGURES	ix
LIST OF TABLES	xi
Chapter 1 INTRODUCTION.....	1
1.1 Background.....	1
1.2 Objectives	4
1.3 Thesis Outline	5
Chapter 2 LITERATURE REVIEW.....	7
2.1 General.....	7
2.2 Resilient Modulus	7
2.2.1 Development of Resilient Modulus Test Protocols	8
2.2.2 Differences among Current Resilient Modulus Test Protocols	10
2.2.3 Influence of Equipment in Resilient Modulus	12
2.2.4 Factors Affecting Resilient Modulus of Soils.....	14
2.3 Soil Suction.....	16
2.3.1 Soil Suction Components.....	16
2.3.2 Soil Suction Measurement Techniques.....	17
2.4 Limes as Subgrade Stabilizer.....	18
2.4.1 Mechanism of Lime Stabilization.....	18
2.4.2 Benefits of Lime Stabilization	19
2.4.3 Lime Stabilization in Pavement Application	20
2.4.4 Studies on Improvement of Engineering Properties	21
2.4.5 Studies on Durability	24
2.5 Resilient Modulus, Suction and Lime Stabilization	26
2.6 Resilient Modulus Models	27
Chapter 3 MATERIALS & EXPERIMENTAL METHODOLOGY	37
3.1 General.....	37
3.2 Material Source and Classification	37

3.2.1 Subgrade Soils	37
3.2.2 Additive Properties	38
3.2.3 Selection of Lime Percentage for Stabilization	38
3.2.4 Moisture-Density Relationships.....	39
3.3 Specimen Preparation and Compaction	40
3.3.1 Sample Size.....	40
3.3.2 Sample Compaction.....	40
3.3.3 Sample Preparation	42
3.3.4 End Treatments	43
3.4 Experimental Program	43
3.4.1 Load and Deformation Measurement Techniques.....	44
3.4.2 Resilient Modulus Test	45
3.4.3 Unconfined Compressive Strength Test	46
3.4.4 Soil Suction Test.....	47
3.4.5 Freeze-Thaw Cycles.....	48
3.4.6 Soaking	48
3.5 Test Matrix.....	49
Chapter 4 EFFECTS OF MOISTURE AND SUCTION ON LIME-STABILIZED SOILS.....	63
4.1 General.....	63
4.2 Resilient Modulus Test Results	64
4.2.1 Untreated Subgrade Soils.....	64
4.2.2 Lime Stabilized Subgrade Soils.....	65
4.3 Unconfined Compressive Strength Test Results.....	67
4.4 Soil Suction Tests	68
4.5 Discussion of Test Results	69
4.5.1 Effects of Confining Pressure	69
4.5.2 Effects of Sample Size.....	70
4.5.3 Effects of Lime Content.....	70
4.5.4 Effects of Molding Moisture.....	71
4.5.5 Resilient Modulus with Soil Suction	72
4.6 Resilient Modulus Models with Suction.....	73

4.7 Summary	76
Chapter 5 DURABILITY STUDY OF LIME-STABILIZED SOILS	92
5.1 General	92
5.2 Freeze-Thaw Durability	92
5.2.1 Resilient Modulus Test Results	93
5.2.2 Unconfined Compressive Strength Test Results.....	96
5.2.3 Effects of Soils Type.....	96
5.2.4 Effects of Lime Treatment	97
5.3 Soaking Durability	98
5.4 Summary	99
Chapter 6 SUMMARY, CONCLUSIONS AND RECOMMENDATIONS	110
6.1 Summary	110
6.2 Conclusions.....	111
6.3 Recommendations.....	114
REFERENCES	116
APPENDIX.....	127

LIST OF FIGURES

Figure 2.1 Concepts of Resilient Modulus	32
Figure 2.2 Schematic of Soil Specimen in a Triaxial Chamber (AASHTO T 307)	33
Figure 2.3 LVDT Locations on Resilient Modulus Testing Equipment.....	34
Figure 2.4 Filter Paper Method for Suction Determination	35
Figure 3.1 Material Collection from the Site	50
Figure 3.2 Processed A-6 and A-7-6 Soil Passing U.S. No. 4 Sieve	50
Figure 3.3 Soil Mixing in Bucket Using Mechanical Mixer	51
Figure 3.4 Split Molds Used for Compaction.....	51
Figure 3.5 Laboratory Compaction Process with Relevant Equipment.....	52
Figure 3.6 Stabilized Subgrade Soil in the Curing Tank	52
Figure 3.7 Capped Plastic Wrap Subgrade Samples.....	53
Figure 3.8 Different Types of Deformation Transducers	53
Figure 3.9 Stepwise Deformation Transducer Setup to Soils	54
Figure 3.10 Stress-Strain Plot with Time for Last Five Sequences of a Typical Resilient Modulus Test.....	55
Figure 3.11 Subgrade Resilient Modulus Test Setup in Triaxial Chamber	55
Figure 3.12 Soil Suctions Measurement with Filter Paper Method.....	56
Figure 3.13 Typical Filter Paper Calibration Curve (ASTM D5298).....	56
Figure 3.14 Units of Freeze-Thaw Chamber	57
Figure 3.15 Samples in Freeze-Thaw Chamber subjected to F-T cycles	57
Figure 3.16 One Freeze-Thaw Cycle	58
Figure 4.1 Resilient Modulus Plot with Deviator Stress for Untreated Subgrade in All Moisture State (Confining Pressure 4 Psi)	77
Figure 4.2 Resilient Modulus Variation among Sample Sizes for 7% Lime Treated A-7-6 Soil.	77
Figure 4.3 Resilient Modulus Plot for Lime Treated A-6 Subgrade Soils.....	78
Figure 4.4 Resilient Modulus Plot for Lime Treated A-7-6 Subgrade Soils	78
Figure 4.5 Stress-Strain Plot for 5% lime Treated A-6 Virgin Samples under Unconfined Compression	79
Figure 4.6 Typical Failure Pattern in Soils after Unconfined Compression Failure	79
Figure 4.7 Total and Matric Suctions with Water Contents for A-6 Soils	80

Figure 4.8 Total and Matric Suctions with Water Contents for A-7-6 Soils	80
Figure 4.9 Variation of Resilient Modulus with Soil and Lime Dose (SD =10 Psi, CP = 0 Psi) .	81
Figure 4.10 Variation of Unconfined Compressive Strength with Soil and Lime Dose	81
Figure 4.11 Percent Increment of Resilient Modulus and UCS with Soil and Lime Dose.....	82
Figure 4.12 Proportion of Osmotic Suction in Total Suction due to Lime Treatment	82
Figure 4.13 Percent Difference from Optimum Moisture in Resilient Modulus Results	83
Figure 4.14 Percent Difference from Optimum Moisture in UCS Results.....	83
Figure 4.15 Suction with Resilient Modulus for all Soils.....	84
Figure 5.1 Resilient Modulus Plot for Raw A-6 Soils Subjected to Different F-T Cycles.....	100
Figure 5.2 Resilient Modulus Plot for Raw A-7-6 Soils Subjected to Different F-T Cycles	100
Figure 5.3 Resilient Modulus Plot for Lime-treated A-6 Soils Subjected to Different F-T Cycles	101
Figure 5.4 Resilient Modulus Plot for Lime-treated A-7-6 Soils Subjected to Different F-T Cycles.....	102
Figure 5.5 Resilient Modulus Plot with F-T Cycles for Different Soil-Lime Combinations (SD=10 psi, CP=0 psi)	103
Figure 5.6 Resilient Modulus Plot with F-T Cycles for Untreated Soils at Different Stress Levels	103
Figure 5.7 Percentage Damage in Resilient Modulus Values for Different Soil-Lime Combinations	104
Figure 5.8 Percentage Damage in UCS Values for Different Soil-Lime Combinations	104
Figure 5.9 Soaked Subgrade Soil Samples	105

LIST OF TABLES

Table 2.1 Differences among Resilient Modulus Test Protocols for Subgrade Soils.....	36
Table 2.2 AASHTO T 307 Load Cell and LVDT Capacity and Range Requirement.....	36
Table 3.1 Subgrade Soils Gradation and Atterberg Limits.....	59
Table 3.2 OMC-MDD of Untreated and Lime-Treated Subgrade Soils.....	59
Table 3.3 Sample Size and Compaction Method According To M_R Test Standards.....	60
Table 3.4 Equivalent Blows per Lift Using Impact Compaction (NCHRP 1-28A)	60
Table 3.5 Test Sequences Adopted For Untreated And Lime-Treated Subgrade Soils.....	61
Table 3.6 Resilient Modulus Test Matrix	62
Table 4.1 Average Resilient Modulus for Untreated Subgrade Soils at All Moisture State	85
Table 4.2 Average Resilient Modulus For Lime-Treated Subgrade Soil For Two Different Sample Sizes	86
Table 4.3 Average Resilient Modulus For Lime-Treated A-6 Soil At All Moisture States	87
Table 4.4 Average Resilient Modulus For Lime-Treated A-7-6 Soil At All Moisture States.....	87
Table 4.5 UCS Results of Virgin and M_R Tested 5% Lime-Treated A-6 Soil Samples.....	88
Table 4.6 Average Unconfined Compressive Strength Results For Untreated And Lime-Treated Subgrade Soils	88
Table 4.7 Soil Suction Results for All Soil Types Using Filter Paper Method	89
Table 4.8 Effects Of Confining Pressure On Resilient Modulus Test Results Of Untreated Subgrade Soils	90
Table 4.9 Sample Size Comparison Using Resilient Modulus Results	90
Table 4.10 Summary of Resilient Modulus Constitutive Models.....	91
Table 5.1 Resilient Modulus Results for Untreated A-6 Subjected to F-T cycles.....	106
Table 5.2 Resilient Modulus Results for Untreated A-7-6 Subjected to F-T cycles	107
Table 5.3 Resilient Modulus Results for Lime-treated A-6 Subjected to F-T cycles.....	108
Table 5.4 Resilient Modulus Results for Lime-treated A-7-6 Subjected to F-T cycles	108
Table 5.5 UCS Results for All Soils Subjected to F-T Cycles	109
Table 5.6 Effect of Soaking on Resilient Modulus Value using Statistical Analysis.....	109

Chapter 1 INTRODUCTION

1.1 BACKGROUND

Traditionally, pavement thickness has been designed empirically (1993 Pavement Design Guide), that is, based on past experience, soil support value, and under static loading (e.g., a plate load or CBR test). Mechanistic-empirical analysis method has been adopted recently by the American Association of State Highway and Transportation Officials (AASHTO) for designing pavements. Resilient modulus (M_R) has been adopted by many State Departments of Transportation (DoT) as an essential input of Mechanistic Empirical Pavement Design Guide (MEPDG) (NCHRP 1-37A, 2004). M_R is used to characterize stress-strain behavior of unbound base, subbase, and subgrade material layers supporting an asphalt surface layer. An accurate determination of resilient modulus is required for designing an optimum pavement thickness. For resilient modulus testing in the laboratory, a cylindrical soil specimen is subjected to combinations of deviator and confining stress in a triaxial pressure chamber. Cyclic load and corresponding recoverable deformation are measured to determine resilient modulus of soil. As resilient modulus testing includes small deviator stresses and small deformation measurements, accurate and precise load and deformation measurements are critical.

Clayey subgrade soils are known to have low resilient modulus under wet conditions. Indeed, clayey soil in the pavement subgrade is potential for unpredictable volume change resulting from wetting and may cause undesirable cracks and damage to structures. Jones and Holtz (1973) stated expansive clay soils as hidden disaster because of its impending damages to constructions, particularly light building and pavements, than any other natural hazard such as floods and

earthquakes. Thus stabilization of clayey subgrade soils has been used widely to transform them into effective construction materials and provide adequate pavement support.

There has been a long tradition to chemically stabilize clayey soils using traditional stabilizer i.e. cement, lime and fly ash to improve engineering properties, such as: plasticity, swelling and moisture holding capacity. Petry and Little (2002) documented the traditional soil stabilization practices in pavements and discussed the practical and research needs to help improve the understanding of stabilized soil behavior. Among different stabilizing agents, lime is the oldest and the most effective stabilizer used by many states including New Mexico. Lime increases the pH value of soils. A pozzolanic reaction between chemicals of clay particles and lime occurs to create a cemented structure that increases the stiffness of treated soils. Thus resilient modulus (M_R) and unconfined compressive strength (UCS) of lime treated soils are expected to be higher than untreated soils (Petry and Little 2002).

One of the main problems with the laboratory resilient modulus testing of treated soils is that there is no well-documented procedure for M_R testing of stabilized soils. The MEPDG recommends two standard protocols for determining resilient modulus in the laboratory namely, AASHTO T 307 (1999) and NCHRP 1-28A (2004), But they are established mainly for untreated subgrade soils. These protocols suggest a low value of stress (2-10 psi) to apply on soil samples. These low stress values result in measurable deformation for the case of untreated soils. However, It is very difficult to capture the minute deformation response of stabilized soils using the low stress sequences suggested in these protocols. Therefore, a modified stress sequence is sought for M_R testing of lime-treated soils in this study.

Resilient modulus values of subgrade soils may be affected by molding moisture content. Construction specifications require compaction of pavement subgrades to more than 90% of maximum dry density and at optimum moisture content (OMC). However, subgrade moisture level can vary with the rising levels in the water table, infiltration of water and inadequate drainage facility (Yang et al. 2005). Khoury et al. (2012) summarized from the past literature that resilient modulus decreases with an increase in moisture content and vice-versa. Though it is believed that the strength of lime-treated subgrade soil is less sensitive due to seasonal variation of moisture, limited studies addressed moisture sensitivity in the laboratory determination of resilient modulus of lime-stabilized soils.

Furthermore, researchers have adopted soil suction concepts to engineering application to understand the effects of soil pore water on soil behavior. Soil suction is a potential energy quantity responsible for water retention. In engineering practice, total soil suction comprises matric and osmotic suction components. Among different measurement techniques, filter paper method is the most inexpensive method to determine total and matric suctions in the laboratory. Yang et al. (2005) and Liang et al. (2008) commented that state of stress of unsaturated clayey subgrade soils are affected by soil suction and included soil suction in developing resilient modulus models for untreated soils only. Therefore, the present study is attempted to investigate the resilient modulus and suction values of untreated and lime treated clayey soils compacted at different moisture states in the laboratory.

Long term performance of pavement structure is influenced by many environmental factors such as freeze-thaw (F-T) cycles and saturation levels. New Mexico is geographically located in

region V of the six climatic regions in the United States (AASHTO, 1986), where pavements are significantly affected by dry climate with F-T cycling. Little (2012) documented past literatures regarding minimal strength loss from laboratory UCS test due to freeze-thaw cycling in lime stabilized soils. Field studies validating the durability of field sections are also reported. Khalife et al. (2012) conducted the laboratory resilient modulus tests on freeze-thaw damaged lime-treated samples of Oklahoma. However, damage percentages are speculated as samples were subjected to high temperature variations suggested by withdrawn ASTM D560 code and capillary action was simulated in the freeze-thaw chamber. This study attempts to conduct M_R tests on samples using available standards of F-T cycles for pavement application. Variation in M_R of freeze-thaw and soaked samples for New Mexico is expected to be helpful in the development of rational subgrade design input considering long term performance of untreated and stabilized clayey subgrade soils.

1.2 OBJECTIVES

The primary objective of this study is to:

- Evaluate the effect of molding moisture contents and soil suctions on laboratory M_R and UCS values of untreated and lime-treated clayey subgrade soils.
- Assess the long-term durability performance of untreated and lime-treated soils due to freeze-thaw actions and simulated field saturation state in the laboratory.

To fulfill these objectives, more specific tasks include the following:

1. Determine the lime demand of raw subgrade soils and develop moisture-density relationships for each soil type with or without stabilization. Prepare and cure the lime stabilized soils according to standard mix design procedure.

2. Conduct the M_R and UCS tests of untreated and stabilized soils with an appropriate test sequences at varying moisture contents. Address the effects of stabilization and moisture on clayey subgrade soils.
3. Determine the suction potential values due to different moisture states of lime stabilized soils correlate resilient modulus with soil suctions.
4. Incorporate suction to traditional stress dependent resilient modulus models and observe the predictive capability for lime treated soils.
5. Conduct the M_R and UCS tests of untreated and stabilized soils for different freeze-thaw cycles and quantify the damage with respect to no freeze-thaw samples.
6. Determine M_R values prior and post soaking in water for untreated and stabilized soils. Compare the results using statistical analysis and understand the significance of lime stabilization in saturated conditions.

1.3 THESIS OUTLINE

Following the background and objectives of this study discussed in Chapter 1, Chapter 2 is a technical literature review focused on previous research relevant to the scope of this thesis. Emphasis is placed on the effect of moisture, suction, durability conditions on laboratory test methods of lime stabilized subgrade soils. Chapter 3 introduces the reader to the materials used in this study, including engineering properties of subgrade soils (such as gradation, moisture density relationship, Atterberg limits etc.). This chapter also includes sample preparation and laboratory test procedures as well as freeze-thaw and soaking durability tests conditions. Laboratory resilient modulus, unconfined compressive strength and soil suction test results at different lime and moisture contents are presented in Chapter 4. Results are presented in tabular

and graphical forms. Associated comparisons are discussed and then constitutive models for untreated and treated subgrade soils are developed. Chapter 5 includes durability performance of untreated and stabilized subgrade soils after the damage due to freeze-thaw cycles and saturation. Contrasts are showed with respect to laboratory M_R and UCS test results. Chapter 6 summarizes the findings and culminates with conclusions and recommendations of this study.

Chapter 2 LITERATURE REVIEW

2.1 GENERAL

This chapter provides an overview of laboratory procedure of resilient modulus, unconfined compression strength test and soil suction tests addressing their effects for raw and lime stabilized subgrade soils. Long term pavement performance with respect to freeze-thaw durability and saturation are also discussed. A brief discussion of resilient modulus concepts and associated issues that can influence the laboratory test results for subgrade soils are presented at the beginning because of their relevance to the present study.

2.2 RESILIENT MODULUS

Resilient modulus (M_R) is a measure of stiffness for unbound and subgrade layers of a highway pavement structure subjected to repeated traffic loading. Mathematically, it is defined as the ratio of peak axial cyclic stress and associated resilient strain (AASHTO 1999). It can be expressed as

Eq. 2.1:

$$M_R = \frac{\sigma_{cyclic}}{\epsilon_r} \quad (2.1)$$

where σ_{cyclic} is the maximum axial cyclic stress, and ϵ_r is the resilient strain associated.

Resilient modulus is analogous to the modulus of elasticity (E) of soils as both properties relate to same basic theory of elasticity definition. Among different laboratory equipment, cyclic triaxial apparatus has traditionally been used for direct measurement of resilient modulus of cohesive and granular materials (NCHRP 1997). Combinations of deviator and confining stresses are applied to the cylindrical specimens to simulate traffic loads a soil element would

experience based on its respective location within the pavement structure and corresponding deformations are measured. Figure 2.1 shows the concepts of resilient modulus determination from laboratory test program.

2.2.1 Development of Resilient Modulus Test Protocols

The concept of resilient modulus was originally defined by Seed et al. (1962) as the ratio of applied dynamic stress (σ_d) to the resilient or recovered (elastic) strain component (ϵ_r) under transient dynamic pulse load. This definition of M_R value was accepted by the pavement community because the elastic pavement deflection showed better correlation to field performance than to total pavement deflection (Witczak et al. 1995)

A sinusoidal stress pulse of varying magnitude is exerted to the pavement structure from traffic. Stress pulse decreases in magnitude, and the pulse duration increases with depth (Lee et al. 1997). This can be simulated by a repeated axial stress that is separated by a rest period applied to a sample confined with a constant static pressure. In a repeated load test, the dissipated energy in a given loading cycle decreases as the number of loading cycles increases. After a number of loading cycles the modulus becomes nearly constant (i.e., materials become resilient) and the response can be assumed approximately elastic. Drumm et al. (1990) defined this steady value as resilient modulus and is assumed to occur after 200 cycles of loading.

The first modern test method for resilient modulus adopted was AASHTO T 274 (1982). In this protocol, vehicle speed and depth beneath the pavement surface were considered in selecting the appropriate axial compressive stress pulse time to use in repeated load testing. The concept of

resilient modulus was subsequently incorporated into the 1986 AASHTO Guide for design of pavement structures. Criticism on these methods was on test procedures, the length of test duration (5 hours), and insufficient description of displacement measurement devices (Puppala 2008).

In 1988, a thorough review of ASHTO T 274 was conducted by the Long-Term Pavement Performance (LTPP) materials Expert Task Group (ETG) and the LTPP team. This group identified areas within the standard that were ambiguous or that required alternatives. Through this process, LTPP Protocol P46, was developed and issued in 1989 with external deformation measurement methods. Over the years, the protocol was revised and amended and was issued in its final form in 1996. In between, AASHTO adopted T 292 (1991) and T 294 (1992) with recommendation of internal deformation measurement techniques and introduction of two parameters regression model. Due to complexity in using internal measurement techniques, P46 was balloted through the AASHTO process and was adopted (with some modification) as AASHTO Standard T 307-1999 (Groeger et al. 2003, Puppala 2008).

Subsequently, National Cooperative Highway Research Program (NCHRP) conducted Project 1-28 (1997) on M_R . The primary objective of this study was to develop enhanced laboratory test procedures for determining resilient moduli of asphalt concrete, aggregate base/subbase materials and subgrade soil using limited multi-lab validation and comparative field measured values. These test protocols more accurately account for varying field conditions, such as temperature of the asphalt surface layer and moisture content of a subbase or subgrade layer with advantages of reduced test time and more reproducible test results. Andrei (1999) went into great

depth in detailing and comparing the four recent standards at that time: AASTHO T 292, T 294, P46 and NCHRP 1-28 Draft-97. The objective was to harmonize existing standards into a single protocol. Many key differences were found between these protocols including: deformation and load measurement locations, stress magnitudes and sequences, confining stresses and unconfined resilient modulus testing, material type characterizations and compaction methods. The result of the Andrei's study was the development of the NCHRP 1-28A (2004) protocol. Currently, two protocols are considered as accepted standards in determining resilient modulus by MEPDG: NCHRP 1-28A and AASHTO T 307. However, none of these protocols have any comments how to conduct M_R testing of lime-stabilized subgrade soils. Figure 2.2 shows the schematic of soil specimen in a triaxial chamber provided by AASHTO T 307.

2.2.2 Differences among Current Resilient Modulus Test Protocols

Differences between the AASHTO T 307 and NCHRP 1-28A protocols for fine-grained subgrades include: deformation and load cell location, stress sequences (number, load duration, magnitudes), sample size and compaction methods. Summary of these differences are listed in Table 2.1 (Cabrera 2012).

2.2.2.1 Load Cell and Deformation Sensor Location

The AASHTO T 307 requires a load cell and spring guided Linear Variable Differential Transducer (LVDT) mount outside the pressure chamber. These are placed inside the triaxial cell in NCHRP 1-28A. Standard gauge lengths are $\frac{1}{4}$ diameter points, i.e. for 2:1 height to diameter samples this is the middle half of the sample for both the methods. The standard includes notes on maximum ranges, and minimum sensitivities. Capacity and range of load cell and LVDTs

according to AASHTO T 307 are listed in Table 2.2. Placement of LVDTs in different locations of triaxial chamber is presented in Figure 2.3.

2.2.2.2 Test Sequences

Both AASHTO T 307 and NCHRP 1-28A use a haversine shaped loading pulse. The duration of the pulse is 0.2 seconds followed by a 0.8 second rest period for NCHRP 1-28A, rather than a 0.1 second pulse followed by a 0.9 second rest period in the AASHTO method. Groupings of test sequences 1-5, 6-10, and 11-15 have confining pressures of 6, 4, and 2 psi, respectively, for fine grained subgrade soil in AASHTO T 307. NCHRP method has 16 test sequences that can be grouped in sequences 1-4, 5-8, 9-12, and 13-16 which have cyclic stresses of 4,7,10, and 14 psi respectively. Moreover, the contact stress is not 10% of the deviator stress for 1-28A and the minimum and maximum cyclic stresses during the test are higher for NCHRP 1-28A than for AASHTO T 307.

2.2.2.3 Sample Size and Compaction Method

Another difference between the two standards is the type of compaction method when reconstituting specimens. AASHTO T 307 mentions multiple methods compaction for fabricating resilient modulus specimens namely, vibratory, static, and kneading compaction. Though AASHTO T 307 allows a standard or modified compaction effort (AASHTO T 99 or T 180) to determine the optimum moisture content and maximum dry density of a remolded resilient modulus specimen, it does not mention standard or modified compaction efforts as a method for fabricating test samples. NCHRP 1-28A allows for impact compaction, however only samples of 4 inch and 6 inch diameters are considered. AASHTO T 307 permits three standard

sizes of resilient modulus specimens: 2.8, 4, and 6 inch diameters with 2:1 height to diameter ratio. However, NCHRP 1-28A does not include reconstituted 2.8 inch diameter specimens, only undisturbed specimens of this size are considered.

2.2.3 Influence of Equipment in Resilient Modulus

Accurate measurements of load and deformation are critical for a successful resilient modulus test. Thus location and precision of load cell and deformation sensors (LVDTs) hold an important factor for correct estimations of resilient modulus in the laboratory.

2.2.3.1 Load Cell

Most load cells used in resilient modulus testing are strain gauge type load cells, with a design stiffness and linear deflection range up to maximum load output. Primary physical issues concerning the load cell in resilient modulus testing are concerned with the location of the load cell, i.e. inside or outside the triaxial cell.

Groeger et al. (2003) pointed concerns for using both external and internal load cells. During the use of an external load cell, attention must be paid to ensure that friction was minimized between the loading piston and the confining chamber. This deformation becomes a concern with T 307 because test deformation measurements are taken outside the triaxial cell, thus load cell deformation contributes directly to strain values and reduces the M_R values. A study performed by Bejarano et al. (2003) supported concern for frictional forces influencing load cell readings when the load cell was placed externally. Results showed that external load readings become 15% higher than internal for high stress measurement. In the conclusion to their study on triaxial

cell interaction examining drag forces on the loading rods, Boudreau and Wang (2003) recommended that internal load and deformations measurements could eliminate or reduce the inherent errors associated with equipment variation. They added that such decision introduces a tester to the difficulty and extra time associated with implementing internal instruments.

2.2.3.2 Deformation Transducer

Historically internal and external deformation techniques for resilient modulus have been shown to produce results, which differ greatly from one another. Boudreau and Wang (2003) concluded that though internal measurements for stress and strain can reduce the errors associated with the equipment variation, M_R test becomes very difficult and time consuming with internal LVDTs. External LVDTs make the test setup less difficult than mounting the internal LVDTs, however many publications have pointed out the difference in values between the two measurement methods and/or the potential influence of erroneous deformations on resilient modulus values when using external LVDTs (Kim and Drabkin 1994, Burczyk et al. 1994, Greoger et al. 2003, Bejarano et al. 2003, Boudreau and Wang 2003, Konrad and Robert 2003). Many of these studies compared measurement on a sample using spring-type LVDTs located in ring clamps on the specimen versus actuator mounted external LVDTs.

Barksdale et al. (1997) and Andrei (2003) found that in regard to deformation measurement, the best method to determine resilient modulus, though more difficult, is fixing buttons to the specimen. Barksdale et al. (1997) included a comparison between the ring clamp and epoxied button LVDTs and concluded that extraneous displacements and potential slip of ring-clamp LVDTs can be eliminated by the epoxied button LVDTs. Andrei (2003) compared internal

measurement setups using synthetic specimens of varying stiffness values and reported questionable results in non-linearity range. He also pointed out that the existing testing standards do not provide for modulus values measured smaller than the non-linearity range. One synthetic sample obtained modulus values of 210 ksi, which the author pointed out is achievable by a subgrade soil in a dry state. Though the resolution was increased 10 times (from a 0.2 to 0.02 in range), one-quarter of the data fell below the non-linearity range. In defense of the non-linearity behavior affecting the resilient modulus, the author showed that in one instance the modulus values decreased and eventually stabilized when the deformation was beyond the non-linearity range while in another instance it increased then stabilized. Since the synthetic specimen used as an example should behave elastically and should not show stress-strain dependency in this case, the author stated that the values at the low strain levels should equal the stabilized values outside the non-linear portion of the LVDTs.

2.2.4 Factors Affecting Resilient Modulus of Soils

The resilient modulus value of cohesive fine-grained subgrade soils decreases with deviator stress due to the softening effect. For granular base and subbase materials, the resilient modulus increases with increasing deviator stress, which typically indicates strain hardening due to reorientation of the grains into a denser state. Factors that affect the resilient modulus of soils are: moisture content, unit weight, loading conditions, loading characteristics, confining stress, compaction method, etc. Within the scope of this study, a brief review of the effect of resilient modulus due to moisture, unit weight and confining pressure are discussed below.

2.2.4.1 Effects of Moisture Content & Unit Weight

Research studies showed that the moisture content and unit weight (or density) have significant effects on the resilient modulus of subgrade soils. The M_R of subgrade soil decreases with the increase of the moisture content or the degree of saturation (Fredlund et al. 1997, Mohammad et al. 1994, Drumm et al. 1997, Huang 2001, Butalia et al. 2003, Heydinger 2003 and Titi et al. 2006). Moisture content is the primary variable for predicting seasonal variation of resilient modulus of subgrade soils (Heydinger 2003, Titi et al. 2006). Mohammad et al. (1994) and Butalia et al. (2003) attributed this reduction in the resilient modulus to an increase in positive pore pressures with an increase in moisture content associated with greater levels of saturation. The effect of the unit weight on the resilient modulus of subgrade soils was largely investigated by Drumm et al. (1997) and Titi et al. (2006). They concluded that the resilient modulus of the soil compacted on the dry side of optimum is larger than that of the soil compacted at the wet of optimum. In regard to material influences, Barksdale et al. (1997) reported that fine grained soils were influenced by moisture changes, with the difference in the resilient modulus between wet and dry conditions being 100% or larger.

2.2.4.2 Influence of Confining Pressure

Confining pressures in the upper soil layers under pavements are normally less than 35 kPa (5 psi). Most laboratory studies on unbound materials showed that the resilient modulus increases with the increment of confining pressure (Seed et al. 1962, Butalia et al. 2003 and Titi et al. 2006). However, studies on cohesive soils showed confining stresses had little effect on resilient modulus values. Thompson and Robnett (1979) found that repeated loading testing with no confining pressure was acceptable for resilient modulus testing of cohesive soils. Fredlund et al. (1977) found that for a soil with a Plasticity Index (PI) of nearly 17 percent, confining stresses

from 3 to 6 psi were insignificant. Muhanna et al. (1999) performed resilient modulus tests on 4 inch diameter A-5 and A-6 samples at varying moisture contents. Authors showed that there was no significant effect due to the number of load applications, rest period, or load sequence. They concluded that confining pressures in the range of 0 to 10 psi had less than a 5% effect on the resilient modulus.

2.3 SOIL SUCTION

Energy state of water in unsaturated soils can be described by suction. Soil suction can be described simply as a measure of the ability of a soil to attract and hold water. From a thermodynamic concept, it is the free energy state of soil water and is a function of relative humidity and moisture. In geotechnical application, soil suction is used to quantify the strength and volume change behaviors of soil water. Though soil suction is a negative pressure opposite to atmospheric pressure but expressed as positive sign in soil mechanics convention.

2.3.1 Soil Suction Components

Among different factors in contributing total suction of soils, matric and osmotic suctions are considered as two prime components (Fredlund and Rahardjo 1993). Matric suction is the negative pressure developed in the soil-water because of capillary and adsorption forces. This parameter is related to soil structure, clay mineralogy and clay chemistry. Different type and amount of clay minerals in soils have different isomorphous substitution and specific surface area which will cause different surface net negative charge and result in different water holding capacity that contribute to matric suction.

Osmotic suction represents suction potential due to balance of dissolved salt concentration in the pore fluid. Concentration of salts or solute in the soil at the top of the capillary zone will develop an osmotic gradient that attracts even more water to the top of the column. Osmotic pressure is related to the concentration of the solute and the vapor pressure of the solution.

2.3.2 Soil Suction Measurement Techniques

There are several devices available to measure soil suctions. Fredlund and Rahardjo (1993) described the measurement devices in three categories according to their use and measuring performance. They are:

- (a) Thermocouple Psychrometers is used to measure high total suction (up to 8,000 kPa or 1,160 psi) in a soil mass;
- (b) Tensiometers is used to measure matric suction less than 90 kPa (13 psi) below which possibilities of cavitation can break the liquid column. Direct measurement of negative pore water pressure can be possible with tensiometers;
- (c) Filter paper method, which is used for indirect measurement of soil suctions. Both total and matric suction can measure separately within the range of 10 kPa to 100,000 kPa.

Though indirect measurement, filter paper method gains popularity in soil science discipline because it is relatively simple and inexpensive. It is also the only method available to measure both the total and matric suctions of an undisturbed or remolded specimen over a wide range of value in the laboratory. Standard soil suction measurement technique (ASTM D 5298-03) is based on the assumption that the water potential of a soil sample is the same as the water potential of a specified filter paper when they are at equilibrium. The equilibrium is reached by

moisture exchanged in a vapor form between the soil sample and the medium (specific filter paper) placed in a closed container. Total suction is determined when the medium is separated from the soil by a vapor gap (non-contact method). Matric suction is determined when the medium is in direct contact with the soil, so dissolved salts are free to move in or out of the medium (contact method). A schematic of sample placement in filter paper method is shown in Figure 2.4. The water content of the filter paper is measured after equilibrium between filter paper and soils (Bulut et al. 2001). Then the corresponding soil suction value can be determined from filter paper calibration curve. Calibration curves are unique for each kind of filter paper and only calibration curves for a specific filter paper can be used to do the total and matric suction measurement. Osmotic suction can be measured by taking the difference between total and matric suction, or by using an indirect measurement from electrical conductivity.

2.4 LIMES AS SUBGRADE STABILIZER

Lime is one of the oldest stabilizing agents known to man. Lime has been used as a very popular chemical amendment in subgrade soils because of its effectiveness by reducing the clay soil plasticity, improving soil workability and compactibility.

2.4.1 Mechanism of Lime Stabilization

Mechanism of lime stabilization is briefly discussed by many authors (Eades and Grim 1960, Boynton 1972, Little 1995, Little 2012). Lime with water takes the form of $\text{Ca}(\text{OH})_2$ and the pH of lime-water solution reaches 12.45 at solubility limit. Clay minerals are comprised mostly of silicates and aluminates. These minerals are break down and react with calcium ions of lime to form calcium-silicate-hydrates (CSH) and calcium-aluminate-hydrates (CAH) or calcium-

aluminate-sulfate-hydrates gels. These gels coat soil particles and subsequently crystallize to bond them together in forming cemented particles. The long term reaction between lime, water and clay soils to form cementing type materials is referred to as soil-lime pozzolanic reaction. Lime provides an excess of Ca^{2+} in secondary reaction and replaces dissimilar cations from the exchange complex of the clay so that there will be a reduction of double diffused water layer. These exchange cations with the clay soil to cause ion crowding and flocculation. Thus lime modifies the clay soil into coarser textured material which is more friable and less plastic.

2.4.2 Benefits of Lime Stabilization

Little (2012) summarized the past literature and concluded three folds of benefits of lime treatment: structural beneficiation, promotion of volumetric stability and structural durability. The resultant engineering properties of lime stabilized soils are based on the degree of and quality of pozzolanic product formed. Pozzolanic reactions in lime stabilized soils can be impacted by soil mineralogy, oxide and sulfate content, degree of weathering, soil-silica that is reactive with lime and organic content of soils (Little 2012). Structural beneficiation is achieved through strength gain as lime-soil reactions can continue for long period of time as long as pH remains above 10 (Eades and Grim 1960). Thus engineering properties of soil-lime mixtures can substantially improve with respect to modulus and compressive strength (TRB 1987). Laboratory testing has revealed the substantial improvement in volumetric stability of soil-lime mixtures due to the plasticity and swell reduction (Little 2012). Structural beneficiation and durability of lime stabilized soils are within the scope of this study and will discuss in detail.

2.4.3 Lime Stabilization in Pavement Application

Stabilization of clay subgrades is a popular alternative for pavement engineers considering the economics of construction with expansive clay soils. Lime is generally used in either powder or slurry form with soils in the pavement to the required shallow depth. For deeper depths, lime piles or lime slurry injection may be used to potentially treat clay soils. Stabilization by high pressure lime slurry injection began in the 1960's. National lime association published its first manual on lime stabilization construction process in 1972 with the mixture design method described by Thompson (1970). The first largest clay improvement project was attempted with this methodology of deeper lime mixing in the construction of Dallas-Fort Worth airport. Another successful approach was the construction of new Denver International Airport with lime stabilized subgrade in the 1990's (Petry and Little 2002). Several researches were conducted to understand the fundamental behavior of soil-lime reaction in expansive and sulfate induced clayey subgrade soils. National Lime Association has developed and documented an approach to account the maximum engineering benefits and construction economics for the use of lime stabilization in pavement application (Little 1999, 2000). The three to four steps design and testing method is termed as Mixture Design and Testing Protocols (MDTP) and approved as part of mechanistic design approach to MEPDG interim guide for lime stabilized soils. According to the procedure, soil that has a PI greater than 10 and more than 25% passing a No. 200 sieve is suitable for lime stabilization. The MDTP procedure recommended accelerated curing of 7 days at 105 °F for laboratory tests as this curing time is short enough to be feasible for mix design purposes yet long enough to provide reasonable values for long term curing at ambient temperature in the field.

As lime-soil reaction is time and temperature dependent and continue for long periods of time (even years), proper curing with extended mixing time is to be ensured in field application for maximum development of strength gain and durability of lime stabilized subgrade soils. If the construction project is considered short term and bottom-line economics rather than life cycle performance, lime application in subgrade layer will be termed as soil modifier not stabilizer.

2.4.4 Studies on Improvement of Engineering Properties

Improvement derived by lime stabilization of clay soils in pavement structure is confirmed by many researchers with the enhancement of resilient properties and overall strength. Resilient properties of lime treated soils are important for structural design of pavements with respect to layer's ability to spread and reduce the induced traffic loads to natural subgrade soils (Little 2012). In other hand, pozzolanic reactions of soil-lime mixtures can substantially improve the long term compressive strength of lime stabilized soils.

Chang (1995) conducted tests on resilient properties of a fine grained Lateritic soil stabilized with CFA and lime. The AASHTO T 274-82 protocol was used for resilient modulus testing with external deformation measurement methods, and obtained M_R values varied between 125 to 250 MPa (18 to 36 ksi). Little (1996) measured resilient modulus of nine Colorado soils and six Texas soils. He found the typical modulus increase is 8 to 15 times than natural subgrade after 24 hours of capillary soak. He also concluded that the stress sensitivity of lime treated soils is noticeably less than the untreated counterpart.

In another study for national lime association, Little (2000) reported that lime stabilization often induced an increase of 1,000% or more in resilient modulus values than that of the untreated soil or aggregate. AASHTO T 294-92 was used for the resilient modulus test on 24 hour capillary soaked samples to simulate critical moisture state in the field. Obtained M_R values are 35.6-79.2 MPa (5.2-11.5 ksi) and 210-625 MPa (30.5-90.6 ksi) for untreated and lime-treated clayey subgrade soil, respectively, but no comment was made for deformation measurement techniques. Values of back calculated (from field Falling Weight Deflectometer (FWD) testing) resilient moduli typically fall within a range of 210 MPa to 3,500 MPa (30 ksi to 507 ksi). Thus, laboratory obtained M_R largely fall behind the field obtained FWD value. Other field study conducted by Maxwell and Joseph (1969) also reported high back calculated moduli of lime stabilized layers at air force base, which was about 1300 MPa to 7000 MPa (190 ksi to 1000 ksi).

Long term strength gain of soil-lime mixture is reinforced by many authors, TRB (1987), George and Uddin (2000), Little (1994, 2000), Geiman (2005), Mooney and Toohey (2010). TRB reported long-term compressive strengths of over 600 psi for lime stabilized soils. Laboratory test results of Little (2000) confirmed UCS values exceed at least 1400 kPa (200 ksi) due to lime stabilization, even as high as 7,000 to 10,000 kPa (1,000 to 1,450 psi). Geiman (2005) concluded among improvement to all soils due to lime treatment, soils with higher clay content showed best improvement as a function of strength increase.

Kim and Siddiki (2006) investigated lime and (lime-Kiln-Dust) LKD in subgrade soils as a soil modifier, not stabilizer. They did the resilient modulus test after just five hours of mixing. They reported that untreated and treated soils showed similar resilient behavior changes due to

changes in confining pressure, and treated soils showed negligible effects due to deviator stresses as compared to the untreated soil. However, the addition of lime and LKD resulted in increased unconfined compressive strengths.

Solanki et al. (2009) conducted intense experiments on engineering properties of four subgrade soils stabilized by lime, CFA and CKD. AASHTO T 307 and ASTM D1633 were used for resilient modulus and unconfined compressive strength tests for all soil combinations. Results showed that all stabilizers improved the strength/stiffness properties from raw soil as formation of crystals within the soil matrix. At lower application rates (3% to 6%), the lime-stabilized soil specimens showed the highest improvement in the strength/stiffness. Maximum improvement in strength was obtained for the soil, which has the lowest PI. However, a reduction in stiffness was obtained for a type of soil beyond a certain percentage of lime addition.

A study performed by Mooney and Toohey (2010) revealed that the relationship between the resilient modulus and UCS in MEPDG level-2 was conservative in its prediction of M_R from UCS. They used external deformation measurement techniques for resilient modulus testing, and obtained small values for the resilient modulus. The researchers concluded that there was no universal equivalent accelerated curing duration for all lime-stabilized subgrade soil with respect to unconfined confined strength results, thus 5 days 100 °F accelerated curing protocol was recommended in field applications.

Though some of the studies mentioned above are relevant to the present study, independent studies for New Mexico are important, as textural and mineralogical characteristics of soils are different in every region.

2.4.5 Studies on Durability

Cycles of freezing and thawing may have a significant influence on the resilient modulus of the pavement system. Titi et al. (2006) commented that freezing results in a sharp reduction in surface deflections while thawing produces an immediate deflection increase. They concluded that decrease in resilient modulus accompanying freezing and thawing is caused by the increase in moisture content and decrease in unit weight.

Long term benefits of lime treatment in soils have been addressed by the researchers in 1960's. Dempsey and Thompson (1968) recorded average rate of strength decrease for lime-soil mixtures of about 120 kPa (17 psi) and 50 kPa (7 psi) per freeze-thaw cycles for 48 hour and 96 hour curing period respectively. Thompson and Dempsey (1969) termed the strength recovery phenomenon of lime stabilized soils as 'autogenous healing'. They found that with achieving sufficient strength from initial field cure, lime stabilized soil layers can support the winter damages with continuous pozzolanic reactions during high temperature period. Past evidence in Little (2012) validated the durability of lime stabilized field sections. Miller et al. (1999) investigated the effect of durability on lime stabilized soils using UCS tests on 7-day cured samples subjected to freeze-thaw cycles. One F-T cycle consisted of placing a sample in a freezer with a temperature of -23 °C (-9.4 °F) for 24 hours, then placing it in a moist chamber

with a relative humidity of approximately 95% for another 24 hours. It was observed that all stabilized samples survived 12 cycles of F-T actions.

McCallister and Petry (1990) addressed the concern of calcium leaching from lime treated soils. Their study revealed that inadequate lime may result in significant leaching and loss of strength for lime treatment, but sufficient lime application with good mixture design practices make the soil-lime mixture highly durable.

Past researchers (Shihata and Baghdadi 2001, Guettalla et al. 2002, Parsons and Milburn 2003, Parsons and Kneebone 2004) examined the freeze-thaw (F-T) durability of stabilized soils using ASTM D560 procedure. These methods have sample preparation and curing techniques for stabilized subgrade soils. Effect of F-T cycles were determined as a percent of weight loss by brushing at the end of desired F-T cycles. With the variability associated in brushing techniques, many agencies discard brushing and replace it with UCS testing (Shihata and Baghdadi 2001). Simonsen and Isacson (2002), Osinubi et al. (2010) and Chen et al. (2010) conducted UCS tests on stabilized samples subjected to F-T action according to ASTM D560 method and found better F-T resistance due to chemical stabilization. According to author's knowledge, only Khalife et al. (2012) and Solanki et al. (2013) examined the resilient modulus values of stabilized soils after F-T actions in Oklahoma using ASTM D560 procedure. However, they obtained high damage (>80%) in stabilized soils due to F-T cycles because of high F-T temperatures and presence of potable water in chamber for capillary action. Indeed, AASHTO was withdrawn ASTM D560 test methods in 2012 with no replacement due to associated high variability. Thus no test methods are currently available to examine the F-T durability of stabilize soils.

Moreover, recent study by Herrier et al. (2012) explored the possibility of using lime treatment in hydraulic structures. They concluded that lime treatment had increased the dimensional stability to the structures with minimal erosion due to non-dispersive nature compare to untreated soil counterpart. No past studies address the freeze-thaw durability of lime stabilized soils with respect to their resilient properties.

2.5 RESILIENT MODULUS, SUCTION AND LIME STABILIZATION

As resilient modulus is sensitive to state of stress and moisture level within the subgrade, it is important to understand the influence of suction on resilient modulus (Yang et al. 2008). Thadkamalla and George (1995) and Uzan (1998) concluded that clayey subgrade soils underneath the pavement exhibit an increase of average moisture content and reach equilibrium condition over time. Thus it is important to predict the moisture content at equilibrium and incorporate their impact in the mechanistic empirical pavement design scheme. Dempsey et al. (1986) used soil suction to estimate moisture content in the subgrade using a moisture equilibrium model. They calculated soil suction with the differences between the negative pore water pressure at certain position above water table and the product of overburden pressure and compressibility of soils. With the direct relationship between suction and moisture for specific soil, they estimated the resilient modulus of that particular soil from its moisture value.

Previous studies (Khoury et al. 2003, Ceratti et al. 2004, Yang et al. 2008) have recognized the direct effect of soil suction on resilient modulus. They reported that M_R increases with an increase in suction and resilient modulus values correlate better with soil suction than moisture content. Khoury et al. (2003), Yang et al. (2004) and Liang et al. (2008) measured the soil

suction for untreated soils using filter paper method. As equilibrium needs much time in filter paper method, they conducted the suction test on samples after resilient modulus test. Khoury et al. (2003) confirmed that resilient suction relates better with matric suction only than total suction. Yang et al. (2004) and Liang et al. (2008) developed resilient modulus predictive models incorporating matric suction in the stress dependent M_R models. However, these models are applicable to untreated subgrade soils only. Yang et al. (2008) developed a suction-controlled resilient modulus test program using axis-translation technique to simulate field representative resilient modulus value for untreated subgrade soils.

For lime stabilized soils, Little (2000) and Solanki et al. (2009) conducted tube suction test to evaluate the moisture susceptibility in volume change performance due to lime treatment. Petry and Jiang (2007) examined suction using both direct (dewpoint potentiometer) and indirect (filter paper) method for lime treated expansive clays of Missouri and Texas. They observed that osmotic suction value increased with the chemical stabilization because of possible ion concentrations in the treated soils. However, the effects of suction potential on resilient modulus of lime treated soils have not been addressed yet.

2.6 RESILIENT MODULUS MODELS

Mathematical models are generally used to express the resilient modulus of subgrade soils represent and address most factors that affect the resilient modulus (Titi et al. 2006). Different models were utilized to correlate resilient modulus with stresses and fundamental soil properties.

Bulk Stress Model

The bulk stress (θ or σ_b) is the sum of the principal stresses σ_1 , σ_2 , and σ_3 . The bulk stress is considered a major factor for estimating the resilient modulus of granular soils. The resilient modulus can be estimated using the bulk stress from the following equation (Titi et al. 2006):

$$M_R = k_1 \theta^{k_2} \quad (2.2)$$

where M_R is the resilient modulus, θ is the bulk stress $= \sigma_1 + \sigma_2 + \sigma_3$, and k_1 and k_2 are material constants.

Although this model was used to characterize the resilient modulus of granular soils, it does not account for shear stress/strain and volumetric strain. May and Witczak (1981) modified the bulk stress model by adding a new factor as follows (Titi et al. 2006):

$$M_R = K_1 k_1 \theta^{k_2} \quad (2.3)$$

where K_1 is a function of pavement structure, test load and developed shear strain.

Deviatoric Stress "Semi-log" Model

The deviator stress is the cyclic stress in excess of confining pressure. The resilient modulus of cohesive soils is a function of the deviator stress, as it decreases with increasing the deviatoric stress. The deviatoric stress model was recommended by AASHTO to estimate resilient modulus of cohesive soils. In the deviatoric stress model, the resilient modulus is expressed by the following equation (Titi et al. 2006):

$$M_R = k_3 \sigma_d^{k_4} \quad (2.4)$$

where σ_d is the deviator stress and k_3 and k_4 are material constants.

The disadvantage of the deviatoric stress model is that it does not account for the effect of confining pressure. For fine-grained soils the effect of confining pressure is much less significant

than the effect of deviatoric stress. However, cohesive soils that are subjected to traffic loading are affected by confining stresses (Li and Selig 1994, Titi et al. 2006).

Uzan Model

Uzan (1985) studied and discussed different existing models for estimating resilient modulus. He developed a model to overcome the bulk stress model limitations by including the deviatoric stress to account for the actual field stress state. The model defined the resilient modulus as follows:

$$M_R = k_1 \theta^{k_2} \sigma_d^{k_3} \quad (2.5)$$

where k_1 , k_2 , and k_3 are material constants and θ and σ_d are the bulk and deviatoric stresses, respectively. By normalizing the resilient modulus and stresses in the above model, it can be written as follows (Titi et al. 2006):

$$M_R = k_1 P_a \left[\frac{\theta}{P_a} \right]^{k_2} \left[\frac{\sigma_d}{P_a} \right]^{k_3} \quad (2.6)$$

where P_a is the atmospheric pressure, expressed in the same unit as M_r , θ and σ_d .

Uzan also suggested that the above model can be used for all types of soils. By setting k_3 to zero the bulk model is obtained, and the semi-log model can be obtained by setting k_2 to zero.

Octahedral Shear Stress Model

The Uzan model was modified by Witzak and Uzan (1988) by replacing the deviatoric stress with octahedral shear stress as follows:

$$M_R = k_1 P_a \left[\frac{\theta}{P_a} \right]^{k_2} \left[\frac{\tau_{oct}}{P_a} \right]^{k_3} \quad (2.7)$$

where τ_{oct} is the octahedral shear stress, P_a is the atmospheric pressure, and k_1 , k_2 , and k_3 are material constants.

AASHTO Mechanistic-Empirical Pavement Design Models

The general constitutive equation (resilient modulus model) that was developed through NCHRP project 1-28A was selected for implementation in the upcoming mechanistic-empirical AASHTO Guide for the Design of New and Rehabilitated Pavement Structures.

The resilient modulus model can be used for all types of subgrade materials. The resilient modulus model is defined by (NCHRP 1-28A):

$$M_R = k_1 P_a \left[\frac{\sigma_d}{P_a} \right]^{k_2} \left[\frac{\tau_{oct}}{P_a} + 1 \right]^{k_3} \quad (2.8)$$

where: P_a is atmospheric pressure (101.325 kPa); σ_d is bulk stress = $\sigma_1 + \sigma_2 + \sigma_3$; σ_1 is major principal stress; σ_2 is intermediate principal stress and is equal to σ_3 for axisymmetric condition (triaxial test) ; σ_3 is minor principal stress or confining pressure in the repeated load triaxial test; τ_{oct} is octahedral shear stress; k_1 , k_2 and k_3 is model parameters (material constants).

The model presented in Eq. 2.8 does not take into account moisture variations, and in order to account for changes in resilient modulus due to seasonal effects an empirical equation is applied to resilient modulus values in MEPDG based on degree of saturation. This model is shown in Eq. 2.9 and is part of the enhanced integrated climatic model utilized by MEPDG (Larson and Dempsy 1997).

$$\log \frac{M_R}{M_{R-opt}} = a + \frac{b-a}{1 + \exp\left(\ln \frac{-b}{a} + k_m(S-S_{opt})\right)} \quad (2.9)$$

where M_R = resilient modulus at a given degree of saturation; M_{R-opt} = resilient modulus at a reference condition; $a = \text{minimum of } \log\left(\frac{M_R}{M_{R-opt}}\right)$; $b = \text{maximum of } \log\left(\frac{M_R}{M_{Ropt}}\right)$; k_m = regression parameter; and $(S - S_{opt})$ = variation in degree of saturation in decimal form. A set of regression constants for two types of soils, coarse-grained and fine-grained, is used in this model.

Liang Model

Liang et al. (2008) have developed a new predictive equation for the resilient modulus of cohesive soils using the concept of soil suction. They used matric suction and stress as state variables to predict resilient modulus of cohesive soils at different levels of moisture content and stress. In addition, Bishop's effective stress relationship has been employed to incorporate the effect of matric suction on resilient modulus. The developed model for estimating the effect of moisture variation on resilient modulus uses effective stress. Assuming pore air pressure equal to zero ($u_a = 0$), the model is given as:

$$M_R = k_1 P_a \left(\frac{\theta + \chi_w \psi_m}{P_a} \right)^{k_2} \left(\frac{\tau_{oct}}{P_a} + 1 \right)^{k_3} \quad (2.10)$$

where, $\theta = \sigma_1 + \sigma_2 + \sigma_3$ is bulk stress, where $\sigma_1, \sigma_2, \sigma_3$ are three principal stresses; τ_{oct} is octahedral shear stress, and for triaxial condition $\tau_{oct} = \frac{\sqrt{2}}{3}(\sigma_1 - \sigma_3)$; ψ_m is matric suction; χ_w is Bishop's parameter; P_a is atmospheric pressure; and k_1, k_2, k_3 are regression coefficients.

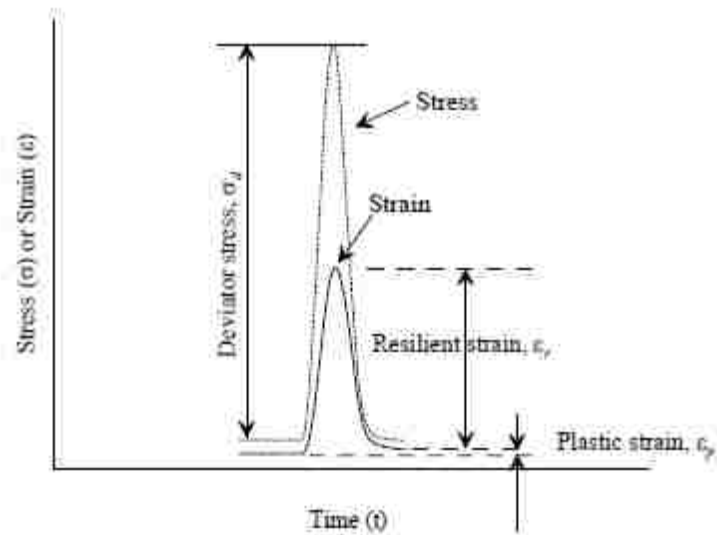

(a) Stresses and strains of one load cycle during resilient modulus test

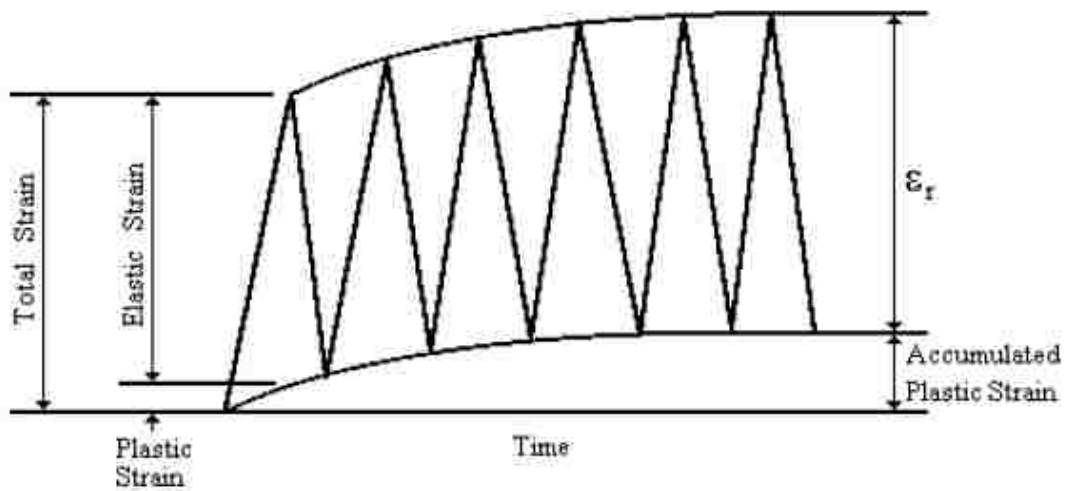

(b) Strains under repeated load

Figure 2.1 Concepts of Resilient Modulus

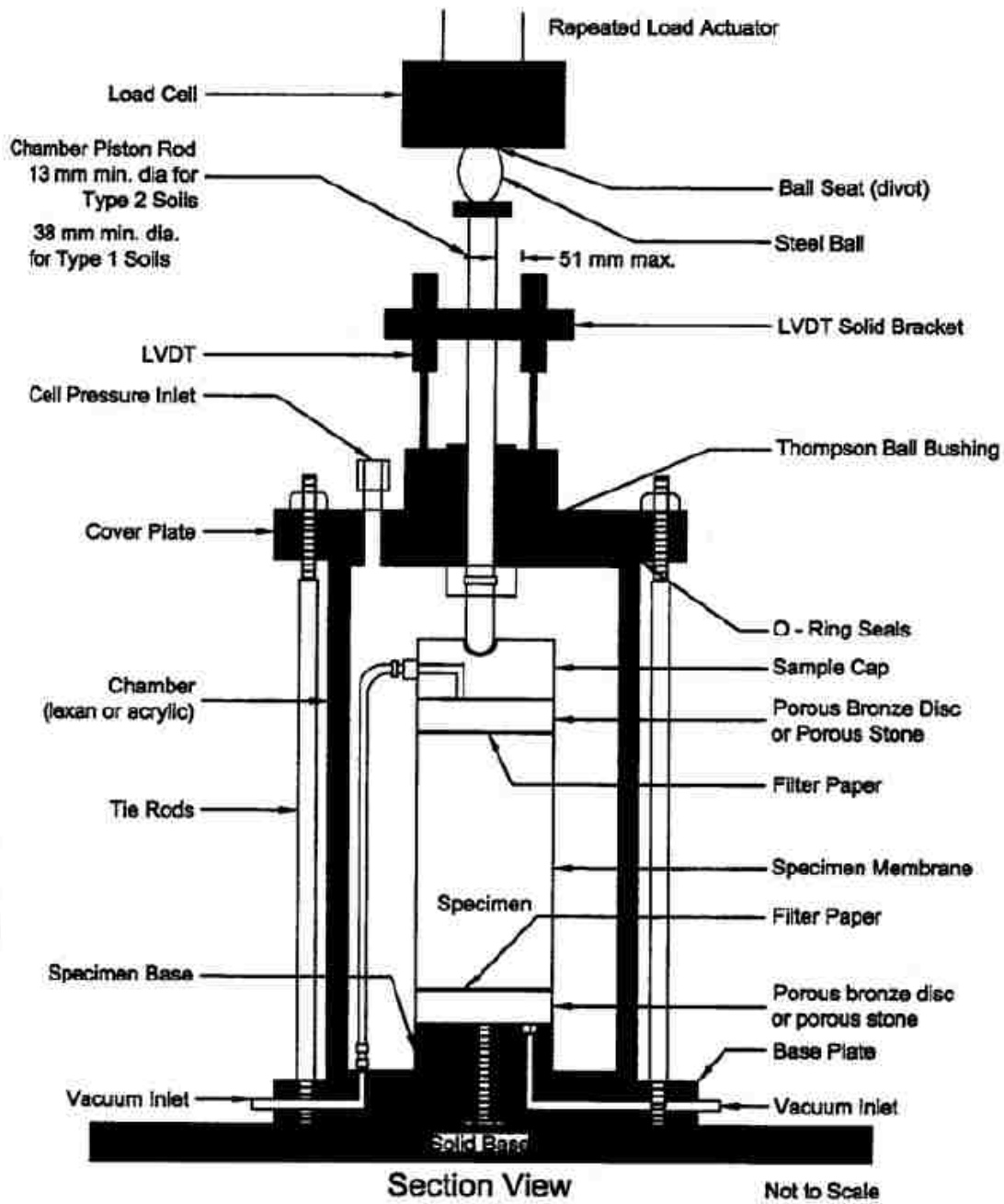

Figure 2.2 Schematic of Soil Specimen in a Triaxial Chamber (AASHTO T 307)

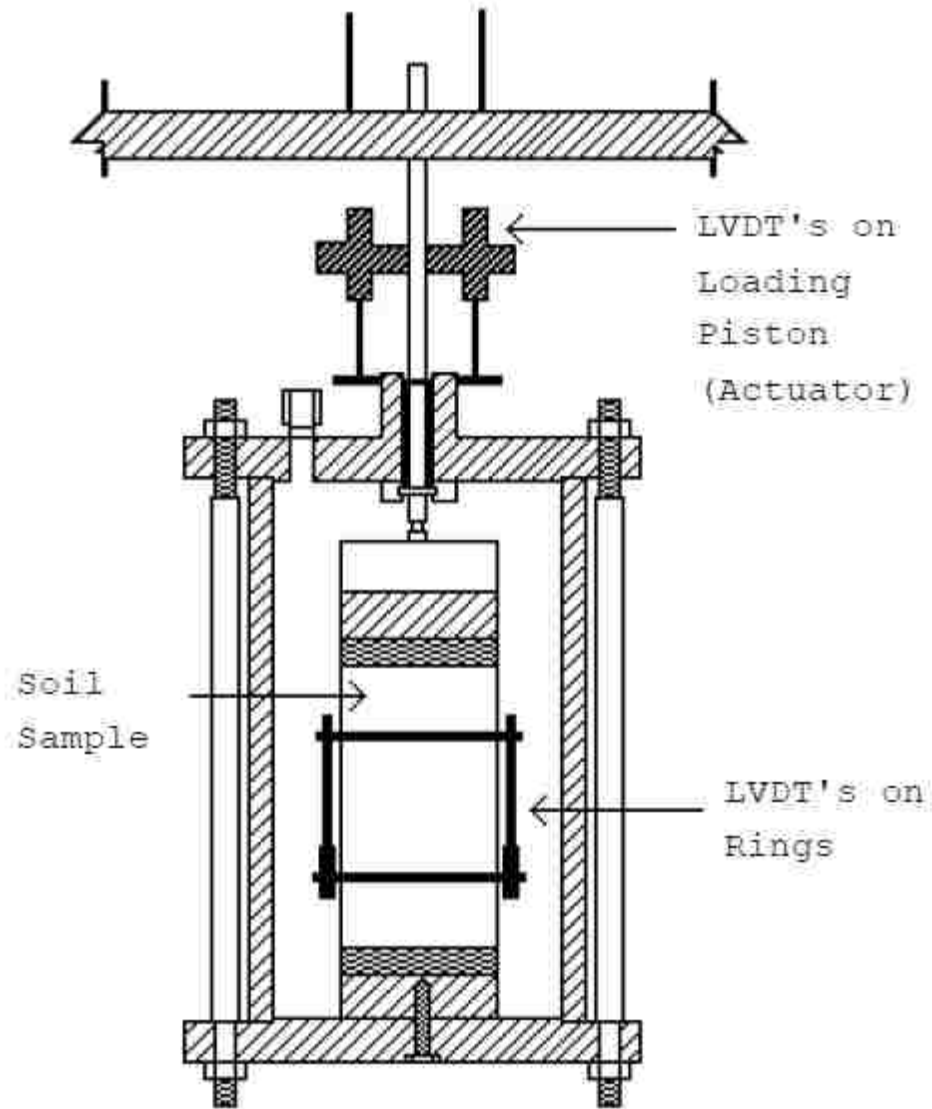

Figure 2.3 LVDT Locations on Resilient Modulus Testing Equipment

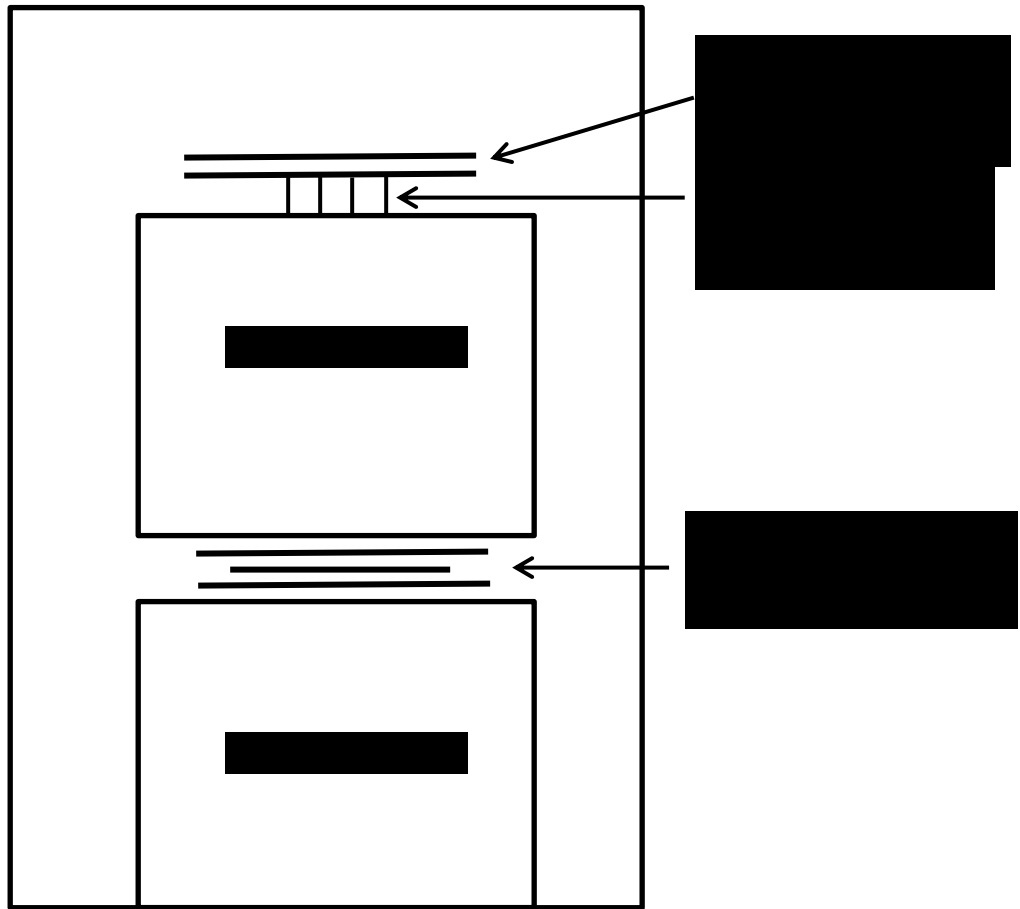

Figure 2.4 Filter Paper Method for Suction Determination

Table 2.1 Differences among Resilient Modulus Test Protocols for Subgrade Soils

Topic	Test Protocol	
	AASHTO T 307	NCHRP 1-28A
Load Cell Location	Outside Cell	Inside Cell
LVDT Location	Outside Triaxial Cell, Mounted on Loading Piston	Inside Triaxial Cell, Attached to Specimen
Option of 2.8 in. Diameter Reconstituted Specimen?	Yes	No
Option of Impact Compaction?	No	Yes
Testing Sequences for Fine-Grained Subgrades	15 ea. 2,4,6,8,10 psi deviator stresses and 2,4,6 psi confining stresses	16 ea. 4,7,10,14 psi deviator stresses and 2,4,6,8 psi confining stresses
Load Pulse Form, Duration	Haversine, 0.1 s	Haversine, 0.2 s

Table 2.2 AASHTO T 307 Load Cell and LVDT Capacity and Range Requirement

Specimen Diameter mm (inch)	Load cell capacity		LVDT range mm (inch)
	Maximum load capacity KN (lbs)	Required accuracy N (lb)	
71 (2.8)	2.2 (500)	±4.5 (±1)	±1 (±0.04)
102 (4.0)	8.9 (2000)	±17.8 (±4)	±2.5 (±0.1)
152 (6.0)	22.2 (5000)	±22.2 (±5)	±6 (±0.25)

Chapter 3 MATERIALS & EXPERIMENTAL METHODOLOGY

3.1 GENERAL

This section highlights the material properties and experimental methodology associated with this study. Materials collection and classification with respect to grain-size distribution, plasticity index, and moisture-density relationships are addressed. Brief description of sample preparation, experimental setup and deformation measurement techniques for resilient modulus and unconfined compression strength testing are included. Limitations of available test protocols for lime-stabilized soils are addressed and new test sequences adopted in this study are described.

3.2 MATERIAL SOURCE AND CLASSIFICATION

Two subgrade soils (AASHTO classification A-6 and A-7-6) were used in this study. Subgrade soils were fabricated and tested in untreated and lime-stabilized conditions. Material sources, grain-size distributions and moisture-density relationships are discussed below:

3.2.1 Subgrade Soils

Subgrade soils were sampled in untreated raw condition from the right-of-way of a highway project on US 491 near Shiprock in northwestern New Mexico. 26 and 34 bags (20 lbs each) of A-6 and A-7-6 materials were collected from Station 6310+00 and 6120+00 respectively. The soils were excavated in large chunks using a backhoe loader at a depth of 5 ft. (A-6) and 3.5 ft. (A-7-6) from the roadway. Shoveling was done to facilitate bagging and transportation of soils in a loose state to the laboratory. After collection, soils were processed and hand pulverized to pass through the U.S. standard No. 4 sieve prior to sample preparation for Atterberg limits and

moisture-density test. Figure 3.1 and Figure 3.2 show field soil collection and processed soil photos. The grain-size distribution of the soils was obtained based on field tests near the project location. Gradation information and Atterberg limit results are summarized in Table 3.1.

3.2.2 Additive Properties

Lime was used as an additive to subgrade soils for this study. Type N hydrated lime was collected from the Lafarge plant of Albuquerque, NM, which was manufactured by Chemical Lime Company of Texas. The manufacturer assured that the provided lime contained calcium hydroxide (>90%), magnesium oxide and hydroxide (<5%), calcium carbonate (<3%) and silicon dioxide (<2%). Other physical and chemical characteristics are: boiling and melting point 2850 °C and 580 °C, respectively, with specific gravity of 2.2-2.4 g/cc.

3.2.3 Selection of Lime Percentage for Stabilization

Prior to perform the moisture-density test, lime requirement of soils were determined using Eades and Grim pH test (ASTM D6276). Subgrade soils were mixed with de-ionized (DI) water and a different amount of lime, periodically shaken and tested using a pH meter after an hour. The pH meter was calibrated using 4, 7 and 10 pH buffers with an R^2 value of 0.98. According to ASTM D6276, the minimum lime content of the soil-lime mixture was confirmed when pH of 12.4 was attained. At this point it indicates that sufficient lime is available to sustain reaction for stabilizing the treated soil.

In the laboratory, it was found that the pH value increased with the increase of percentage of lime. For A-6 and A-7-6 soil, pH of 12.4 was attained at lime percentages of 4 percent and 5

percent, respectively, indicating the minimum lime content for these soils. NMDOT's standard practice of testing soil-lime mixture is 3, 5 and 7 percent. Thus, 5% and 7% was selected as the two lime dosages for this study.

3.2.4 Moisture-Density Relationships

Moisture density relationships for subgrade and base aggregate were established according to AASHTO T 180 using a modified proctor test. Soils were compacted to five points (on dry and wet side) to determine the maximum dry density and optimum moisture content. Moisture contents for both loose soil and the compacted solid sample were measured after oven-dried at 240 °F for 24 hours. The assumed and actual moisture content varied within 1%. The optimum moisture content (OMC) and maximum dry density (MDD) for untreated and lime-treated subgrade soils and aggregate base soil are summarized in Table 3.2.

Sufficient quantities of soils passing the No. 4 sieve were obtained in order to determine the OMC and MDD. A manual mechanical mixer was used to mix soil, water and lime (when required) based on dry unit weight of soils in a 5 gallon plastic bucket (Figure 3.3). The mix was then sealed and allowed to settle prior to compaction. Moisture-density test results of untreated subgrade soils indicated that A-6 soils had OMC and MDD of 15.1% and 120 pcf (19.7 kN/m³) respectively. For A-7-6 soil, OMC and MDD were found to be 14.7% and 124.5 pcf (20.4 kN/m³) respectively.

For lime-treated soils, two percentages of lime (5% and 7%) were added with two subgrade soils based on the dry weight of the soils. The soil and lime were mixed for a minute in dry state and 5

minutes or more with DI water until uniformity in the soil mix was achieved. Laboratory results (Table 3.2) showed an increase in OMC and decrease in MDD with the increase in percentage of lime for each soil. Little (1996) reported that OMC increases with the increase of lime content because sufficient water is available for the soil-lime chemical reactions. Solanki et al. (2009) commented that such behavior could be attributed to the increased number of fines in the mix due to the addition of lime.

3.3 SPECIMEN PREPARATION AND COMPACTION

3.3.1 Sample Size

In general, there are three standard sizes of resilient modulus samples: 2.8, 4, and 6 inch diameters with 2:1 height to diameter ratio. Fine grained cohesive soils meet the AASHTO T 307 criteria for being reconstituted into a 2.8 inch diameter sample size according to the largest particle diameter being smaller or equal to one-fifth the size of the mold diameter. Conversely, NCHRP 1-28A does not allow 2.8 inch diameter samples. Thus, cylindrical 4 inch (101.6 mm) diameter by 8 inch (203.2 mm) height sample size was selected for subgrade soils as it is recommended by both protocols. In the interest of using less material, time and effort, the 2.8-inch sample size for subgrade soil gains popularity. Therefore, 2.8-inch lime stabilized specimens were prepared and test results were compared with 4 inch samples.

3.3.2 Sample Compaction

AASHTO T 307 requires a standard or modified compaction effort to determine OMC and MDD of a remolded resilient modulus specimen, but it does not mention standard or modified compaction efforts as method for fabricating test specimens. NCHRP 1-28A allows for impact

compaction. Table 3.3 summarizes the sample size and compaction methods followed by AASHTO T 307 and NCHRP 1-28A.

Barksdale et al. (1997) and Muhanna et al. (1999) showed the effect of impact versus kneading compaction. They concluded that resilient modulus of cohesive subgrade soils do not significantly affected particularly those compacted at optimum and wet of optimum conditions. In addition, they commented on the difficulty in obtaining target densities and moisture contents when using kneading compaction as well as on the fact that impact compaction is the standard which dictates in-situ values. While moisture-density relationships used for this study are defined using energy delivered by impact compaction, NCHRP 1-28A standard for impact compaction is considered for both subgrade and granular base soils. Impact compaction energy was provided by a modified proctor effort, which delivers 56,000 ft-lbf/ft³. In order to reconstitute different sample diameter using impact compaction for this study, necessary number of blows per layer was calculated using Eq. (3.1) from NCHRP 1-28A.

$$n = \frac{CE*V}{N*W*h} \quad (3.1)$$

For modified proctor effort:

n = number of blows, CE = compactive effort of 56,000 ft-lbf/ft³, V = volume of specimen, N = number of layers, W = weight of drop hammer (10 lbf), h = drop height in feet (1.5 ft).

Based on equivalent energy delivered by the modified proctor hammer, it was found that desired densities of 95-100% of maximum dry density were always achieved. Table 3.4 summarizes number of blows per lift for different sample size.

3.3.3 Sample Preparation

All samples were compacted in split molds lined with membranes and vacuum pressure applied. Figure 3.4 shows the different size of split molds used in the study. Vacuum ports at two locations, especially at a point near the highest lift, were needed due to the pressure of the soil on the membrane sealing the lower port and cutting off the vacuum. When this happens the membrane becomes loose and can get caught by the proctor hammer and in between the lifts cause deformities in the samples. Also, multiple reinforcing hose clamps were needed to keep the split mold closed during compaction. Figure 3.5(a) depicts the photograph of a 2.8 inch diameter mold with the membrane and vacuum connection. The modified proctor hammer and impact compaction process for soil preparation is shown in Figure 3.5(b).

Subgrade soils were fabricated at three different lime percentages (0%, 5%, 7%) and three different moisture states, i.e., dry (OMC-2%), optimum and wet (OMC+2%). Raw processed subgrade soils (passing through No. 4 sieves) were mixed with water to achieve 1% greater than target moisture content to overcome moisture loss during the time of reconstitution, storing and test preparation. During compaction, weights of each lift were determined based on desired specimen densities and as mixed moisture contents. 4 inch diameter specimens were compacted with target dry densities between 95-100% of maximum dry density. Target ranges for dry and wet samples were $\pm 2-3\%$ relative to optimum moisture contents.

Lime-stabilized subgrade soil mixing was performed according to ASTM D3551, the same as described for the OMC and MDD determination. After mixing, soils were stored in a plastic bucket for at least 8 hours for the mellowing purpose. Then, the mixture was compacted in

cylindrical molds of 2.8 inch and 4 inch diameter. A curing tank was set up to cure samples in an accelerated manner at 105 °F for 7 days (Little 2000). Samples were fully sealed with combinations of several rounds of plastic wrap and plastic bags. Then they were placed in the cylindrical plastic containers and submerged in water to ensure accelerated reaction of lime through the heating process. Figure 3.6 illustrates storing of treated soil in the curing tank with insulating foam in the top of the tank.

3.3.4 End Treatments

Difficulties were encountered in achieving smooth surfaces when using impact compaction and split molds. Samples were capped (when required) in this study to ensure smooth top surfaces required for even stress distributions during testing (Mooney and Toohey 2010). The material used for capping was gypsum cement with a 0.45 water to cement ratio. Only the top end of the sample that was directly exposed to the impact hammer was capped, the bottom had a smooth finish. Figure 3.7 shows capped samples with portions of plastic containers and hose clamps. Samples were capped immediately after compaction, sealed with plastic wrap and stored in cylinder container to mitigate moisture loss.

3.4 EXPERIMENTAL PROGRAM

Two tests were conducted on each soil combination, i.e. the resilient modulus test and the unconfined compressive strength test. These have been done for samples with 0, 1, 10, 20 freeze-thaw cycles. Soil suction test was separately performed on subgrade soils with different moisture and lime contents.

3.4.1 Load and Deformation Measurement Techniques

Load and deformation measurements play vital roles in accurate estimation of resilient modulus values. For correct estimation of resilient modulus, LVDTs are to be mounted on the specimen and load cell is to be placed within the triaxial cell. These have been ensured to minimize the extraneous deformation from load cell and system compliance. Cabrera (2012) compared external and internal deformation measurements and concluded that the majority (>80%) of the deformations were extraneous when measuring externally.

UNM Pavement laboratory has two types of LVDTs (Figure 3.8) for deformation measurements of subgrade soils. Cabrera (2012) performed the comparison among them and concluded spring guided LVDTs are the best method for precise measurement of deformation at any axial stress during the resilient modulus test. This deformation measurement setup is the same as the one used for dynamic modulus testing of asphalt samples. The technique is termed as ‘spring guided glued button’ as the metal buttons (1/4 inch diameter by 3/8 inch height) are required to put in the holes at a distance of the gauge length, then epoxy glued to the sample. It is considered to be the best method to measure the deformation on the specimen due to loading, though it requires much effort and time to put the buttons and set the epoxy. Figure 3.9 depicts the stepwise procedure of (a) buttons placement, (b) setting up LVDT holders to the soils and (c) subgrade soils with spring guided LVDTs.

As LVDT requirements provided in AASHTO T 307 are mentioned for external use (Table 2.1), it was sufficient to use one grade lower i.e. ± 0.04 inch (± 1.0 mm) range LVDTs for subgrade soils. Strain gauge internal load cells having capacity of 500 lb (2.2 kN) and 2000 lbs (9 kN)

were used for 2.8 inch and 4 inch diameter subgrade resilient modulus testing. However, 25000 lbs (100 kN) capacity was used for UCS testing of lime stabilized soils due to their expected high strength at failure point.

3.4.2 Resilient Modulus Test

Resilient modulus test for untreated subgrade soils was conducted according to AASHTO T 307 test sequences for subgrade soil (Table 3.5). The test procedure consists of different combinations of deviator and confining stresses applied in 15 stress sequences. Additionally, untreated subgrade soils were tested for unconfined state with same deviator stress to observe the effects of confining pressure on resilient modulus values. Haversine shaped load form of $(1 - \cos\theta/2)$ is applied in a triaxial pressure chamber. This is the recommended pulse shape to simulate the induced load in pavement layers (Barksdale et al. 1997). Each test sequence has 0.1 seconds of load pulse and 0.9 seconds of rest period. Resilient modulus for a particular test sequence is determined by averaging the last five cycles. Stress and strain behaviors for the last five cycles of a typical test sequence are illustrated in Figure 3.10. Two criteria were maintained for reporting successful M_R test results:

1. Vertical deformation ratio (R_V) of two internal linear variable deformation transducers (LVDTs) needs to be less than 1.5.
2. Coefficient of variance (COV) of last five cycles M_R value stays within 5.

Testing of treated materials using test sequences of untreated soils (AASHTO T 307) was a concern to Barksdale et al. (1997) because untreated soils' stress sequences are not large enough to produce measureable deformations using internal LVDTs for treated soils. At the same time, it

was understood that higher stresses are not representative of those experienced by a soil element in the subgrade level. However, due to limitations of the test protocols in regards to very stiff materials, high stress sequences are needed for the LVDTs to respond outside of the typical non-linearity error range. Moreover, the preconditioning stage and confining pressure has little effect on resilient modulus of the subgrade soil (Muhanna et al. 1999). Based on the literature and laboratory experience gathered from the present study, it was decided to conduct the M_R test on lime-treated soils at unconfined high stress sequences (i.e. deviator stress of 10, 15, 20, 25, 30, 40 and 50 kPa) with 200 preconditioning cycles. Table 3.5 summarizes test sequences used for this study for different soils. Figure 3.11 shows the universal testing system (FRM 100/SCON 1500) with subgrade soil sample.

3.4.3 Unconfined Compressive Strength Test

Unconfined Compressive Strength (UCS) is an important design indicator of mechanical behavior of subgrade soils according to MEPDG. Thus, UCS test was conducted on both untreated and lime-treated samples in which resilient modulus test was conducted before. Additionally, one type of soil (A-6 with 5% lime) was compacted and tested for UCS without any resilient modulus test after 7 days of curing. AASHTO T 208 and ASTM D5102 are the standard test methods of UCS for untreated and lime-stabilized subgrade soil respectively. These two methods have a difference in maximum strain limits (15% and 5% for untreated and lime stabilized soil respectively), but strain rate is same. A strain control test program was created within the software giving a displacement rate command that equated to a strain rate of 0.5% per minute. The test was stopped either at the maximum axial strain level or the maximum stress attained, whichever comes earlier. A low precision frame mounted LVDT (± 2 inch) was used for

strain measurement. Thus, the LVDTs used for resilient modulus testing are not adequate for the UCS test because the deformation is high enough to destroy them at failure point.

3.4.4 Soil Suction Test

Filter paper method, specified in ASTM D5298, is adopted to measure the total and matric suction of raw and lime-treated subgrade soils. As soil suction can vary with soil type, compaction condition; samples were prepared in a same impact compaction method as resilient modulus samples to get comparable results for different soil combinations. Approximately 1 inch (25.4 mm) height of soils were compacted in 4 inch (101.6 mm) diameter split mold in 2 layers and placed them in plastic container for equilibrium. The soil suction measurement was followed according to the technique described by Bulut et al. (2001). Three (3) filter papers were placed in between soil layers to ensure direct contact for matric suction measurement from inner filter paper. Total suction was measured from two (2) filter papers which were positioned at the top of the soil in the same container with a small disk (non-contact). Figure 3.12 illustrates the suction measurement techniques used in the laboratory. The filter papers used in this study were Whatman No. 42, ashfree quantitative Type II with a diameter of 55 mm. 10 days equilibrium period was considered. After achieving equilibrium, the water contents of the soils and filter paper are measured by weighing them on a high precision analytic balance. Suction is calculated using a predefined filter paper calibration curve (ASTM D5298). A typical calibration curve for filter paper method consists two parts, as shown in Figure 3.13. The upper segment represents moisture retained as films absorbed onto particle surface, while the lower segment represents moisture retained by capillary or surface tension forces between particles.

3.4.5 Freeze-Thaw Cycles

Based on literature, there is no standard laboratory test procedure available to examine the effect of F-T durability on resilient modulus of lime stabilized subgrade soils. ASTM D560-03, standard test methods for freezing and thawing of compacted soil-cement mixtures, was used widely to assess F-T durability of stabilized soils before. However, this standard was withdrawn with no replacement by ASTM committee in 2012 due to high variability associated with the test procedures. ASTM C1645, standard test method for freeze-thaw durability of concrete paving units, is considered for this study. A temperature and humidity chamber was used for controlling freezing and thawing of samples. The chamber is a high performance unit with temperature and humidity fluctuation of ± 0.3 °C and $\pm 2.5\%$ respectively. Figure 3.14 shows the units of the chamber and Figure 3.15 presents the chamber with soil samples. According to ASTM C1645, one F-T cycle consisted of freezing at a temperature of -5 °C (23 °F) for 16 hours and thawing at $+30$ °C (86 °F) for 8 hours. This temperature range is suitable for New Mexico environment, thus one F-T cycles can be assumed as one year of F-T in pavement field application for subgrade level. The variations of temperature in each cycle are shown schematically in Figure 3.16. 10 and 20 F-T cycles were considered for this study. An additional 1 F-T cycle was considered for untreated soils.

3.4.6 Soaking

An optimum state sample for each soil combinations was compacted, cured and tested before and after full soaked in water. After first set of resilient modulus tests, samples were placed in bucket with full of water for 48 hours. Resilient modulus test was conducted again in soaked sample and failed to unconfined compression.

3.5 TEST MATRIX

This study dealt with two subgrade soils with three lime percentages, thus accounted six soil combinations in total. For laboratory testing with no freeze-thaw, two replicate 4 inch samples (in some cases triplicate) were prepared at three different moisture contents i.e. dry (OMC-2%), optimum (OMC) and wet (OMC+2%). Triplicate 2.8 inch diameter lime treated samples were reconstituted at optimum moisture content to evaluate the sample size effect. Thus total 55 (fifty-five) samples were prepared for resilient modulus testing at no freeze-thaw condition. Moreover, 12 samples (6 each for 2.8 inch and 4 inch diameter) 5% lime treated A-6 soil were compacted and cured for conducting only unconfined compression strength test. 18 combinations (6 soils and 3 water contents) were sampled separately for soil suction measurement.

For durability assessment, one 4 inch sample was compacted at OMC for each F-T cycles. Three (1, 10, 20) and two (10, 20) F-T cycles were considered for untreated (2 soils) and lime stabilized soils (4 soils) respectively. These totaled to 14 samples to assess F-T damage. One OMC sample with no F-T was taken to conduct soaking test. Table 3.6 illustrates the overall resilient modulus test matrix for this study.



Figure 3.1 Material Collection from the Site



Figure 3.2 Processed A-6 and A-7-6 Soil Passing U.S. No. 4 Sieve



Figure 3.3 Soil Mixing in Bucket Using Mechanical Mixer



Figure 3.4 Split Molds Used for Compaction

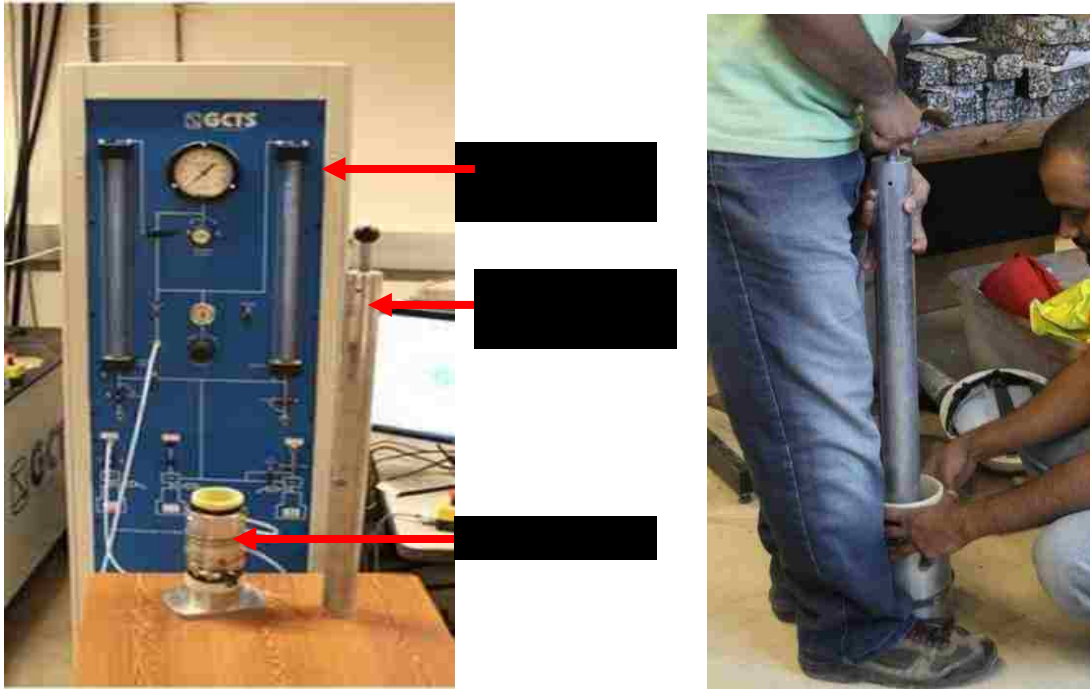

Figure 3.5 Laboratory Compaction Process with Relevant Equipment



Figure 3.6 Stabilized Subgrade Soil in the Curing Tank



Figure 3.7 Capped Plastic Wrap Subgrade Samples



Figure 3.8 Different Types of Deformation Transducers



Figure 3.9 Stepwise Deformation Transducer Setup to Soils

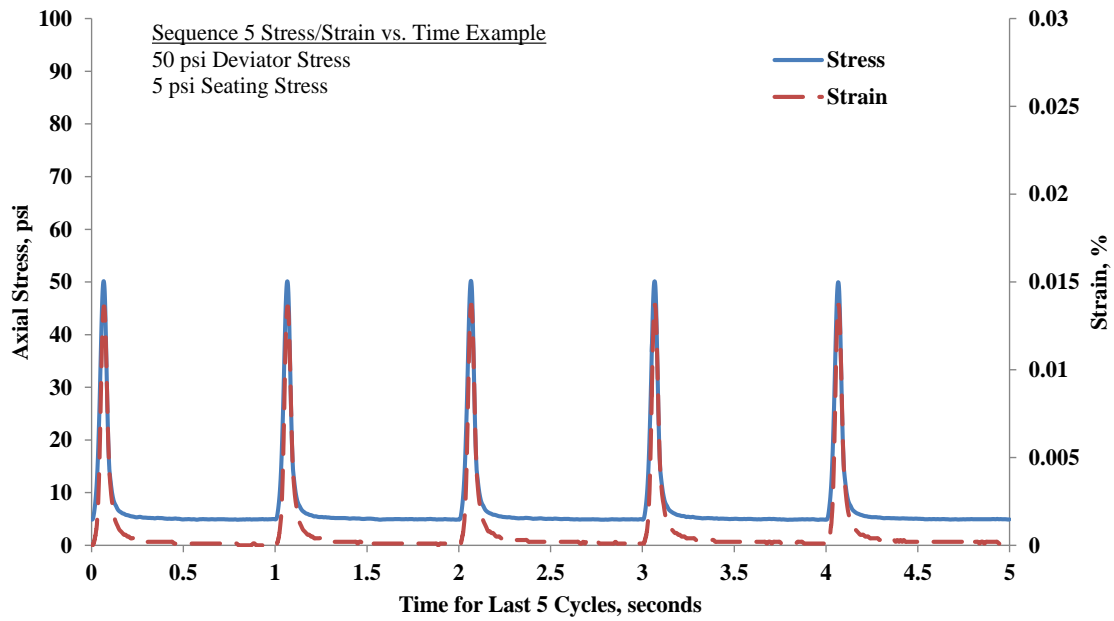

Figure 3.10 Stress-Strain Plot with Time for Last Five Sequences of a Typical Resilient Modulus Test

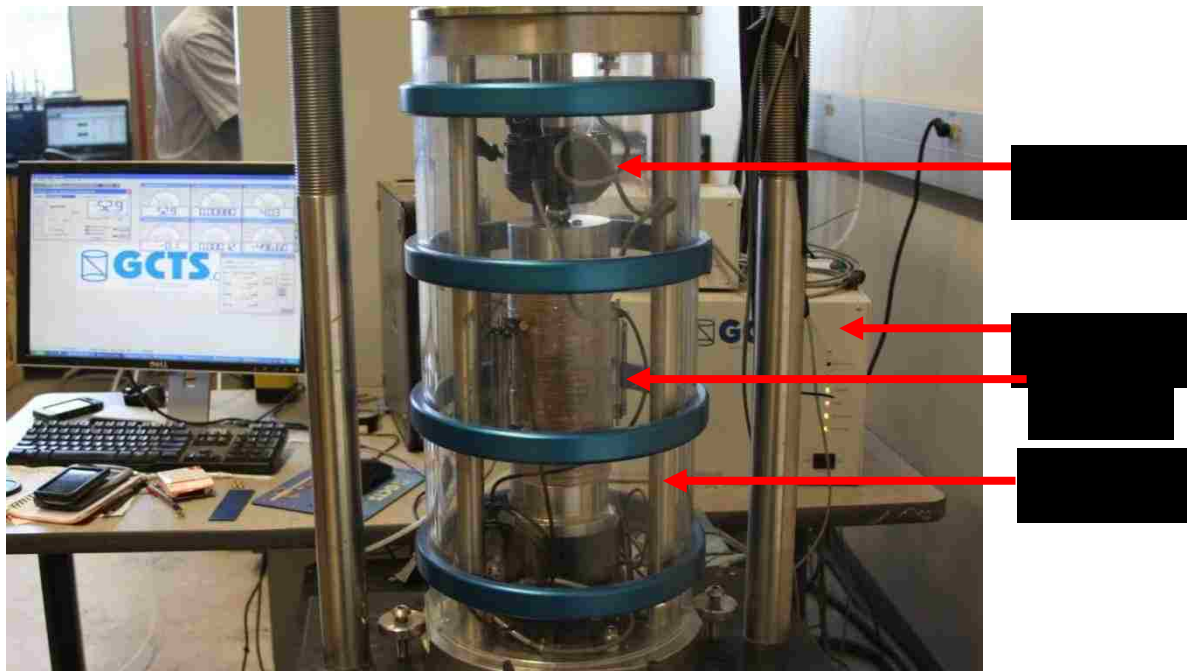

Figure 3.11 Subgrade Resilient Modulus Test Setup in Triaxial Chamber



Figure 3.12 Soil Suctions Measurement with Filter Paper Method

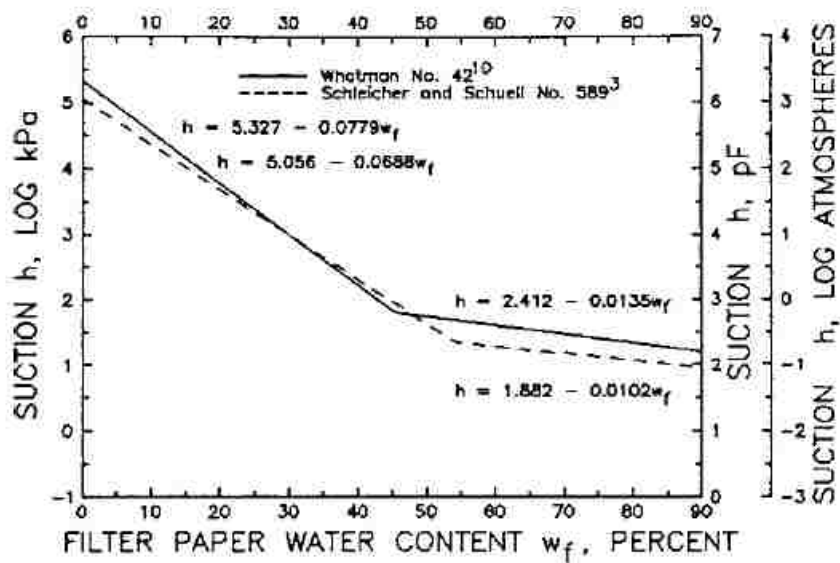

Figure 3.13 Typical Filter Paper Calibration Curve (ASTM D5298)

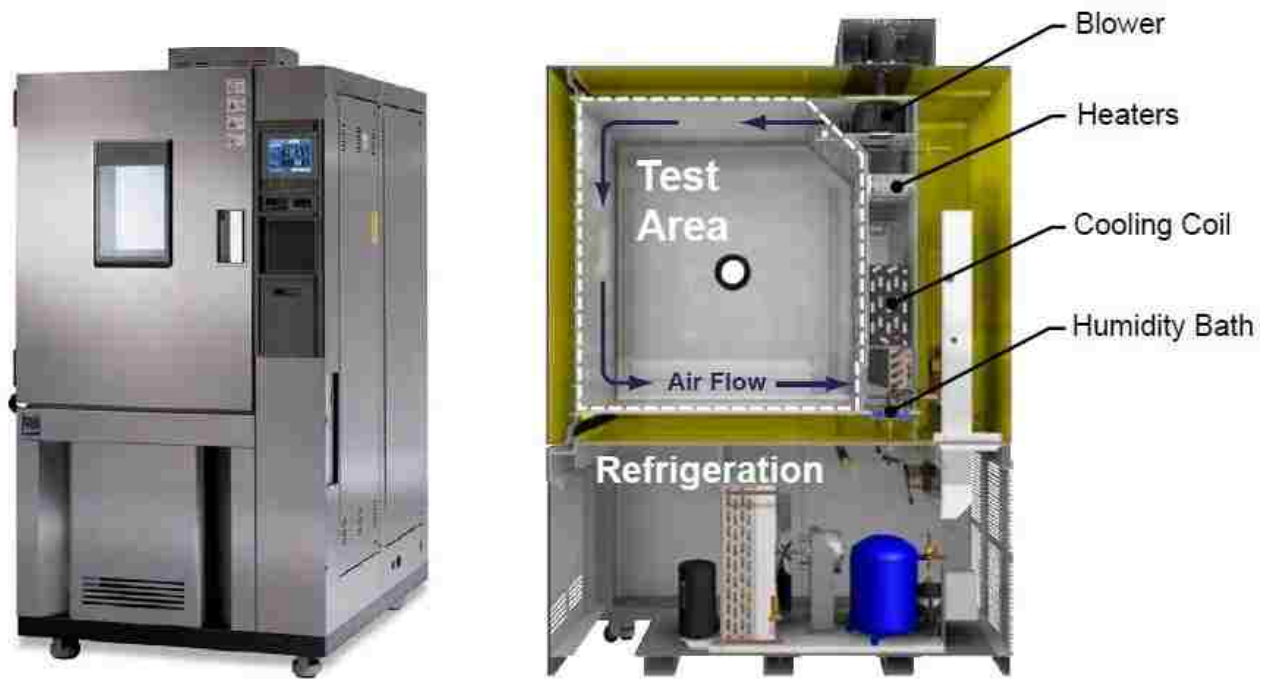

Figure 3.14 Units of Freeze-Thaw Chamber



Figure 3.15 Samples in Freeze-Thaw Chamber subjected to F-T cycles

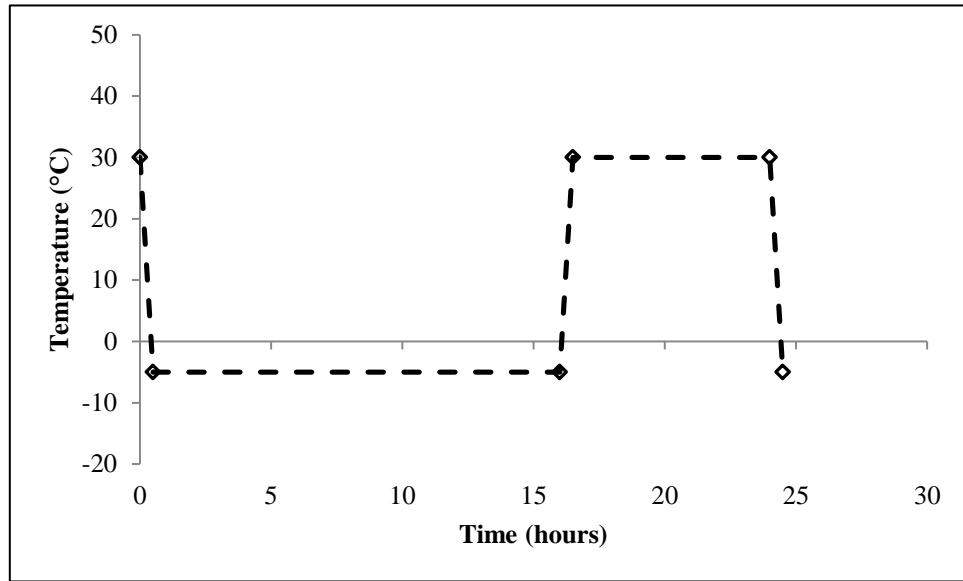

Figure 3.16 One Freeze-Thaw Cycle

Table 3.1 Subgrade Soils Gradation and Atterberg Limits

Soil Designation		
AASHTO classification	A-6	A-7-6
USCS Symbol	CL (lean clay)	CH (fat clay)
Gradation		
Sieve Opening	% passing	
1 inch	100	100
3/4 inch	100	99
1/2 inch	100	98
3/8 inch	100	97
No. 4	100	95
No. 10	98	93
No. 40	96	91
No. 50	53.7	90
No. 200	49.6	74.2
Atterberg Limits		
Liquid Limit	29	69
Plastic Limit	16	27
Plasticity Index	13	42

Table 3.2 OMC-MDD of Untreated and Lime-Treated Subgrade Soils

Type of Soil	% of lime additive	OMC (%)	Maximum Dry Density	
			pcf	kN/m ³
A-6	0	15.1	120.0	19.7
	5	17.2	110.6	18.1
	7	18.2	109.2	17.9
A-7-6	0	14.7	124.5	20.4
	5	16.4	115.0	18.9
	7	17.5	114.5	18.8

Table 3.3 Sample Size and Compaction Method According To M_R Test Standards

Test Standard	Reconstituted Mr specimen diameter (in.)		
	2.8	4.0	6.0
AASHTO T 307	Static, Kneading, Vibratory	Static, Kneading, Vibratory	Static, Kneading, Vibratory
NCHRP 1-28A	N.A.	Impact, Kneading, Vibratory	Impact, Kneading, Vibratory

Table 3.4 Equivalent Blows per Lift Using Impact Compaction (NCHRP 1-28A)

Specimen Diameter (in)	2.8	4	6
Compactive Effort, CE (ft-lbf/cft)	56000		
Volume of specimen, V (cft)	0.02	0.058	0.196
No of Lifts, N	3	8	27
Weight of drop hammer, W (lbf)	10		
Drop height, h(ft)	1.5		
No of blows/lift, n	~25	~27	~27

Table 3.5 Test Sequences Adopted For Untreated And Lime-Treated Subgrade Soils

Sequence Number	Untreated Subgrade soil		Lime-treated Subgrade soil	
	Confining pressure, psi (kPa)	Deviator Stress, psi (kPa)	Confining pressure, psi (kPa)	Deviator Stress, psi (kPa)
Conditioning	6 (41.4)	4 (27.6)	0	8 (55.1)
1	6 (41.4)	2 (13.8)	0	10 (69)
2	6 (41.4)	4 (27.6)	0	15 (103.4)
3	6 (41.4)	6 (41.4)	0	20 (138)
4	6 (41.4)	8 (55.1)	0	25 (172.4)
5	6 (41.4)	10 (68.9)	0	30 (206.8)
6	4 (27.6)	2 (13.8)	0	40 (275.8)
7	4 (27.6)	4 (27.6)	0	50 (344.8)
8	4 (27.6)	6 (41.4)		
9	4 (27.6)	8 (55.1)		
10	4 (27.6)	10 (68.9)		
11	2 (13.8)	2 (13.8)		
12	2 (13.8)	4 (27.6)		
13	2 (13.8)	6 (41.4)		
14	2 (13.8)	8 (55.1)		
15	2 (13.8)	10 (68.9)		

Table 3.6 Resilient Modulus Test Matrix

Type of soil	% of additive used	Sample size: 4 inch			2.8 inch	Total samples	Remarks
		Moisture State					
		Dry	Optimum	Wet	Optimum		
Subgrade A-6	0	3	3	3	-	9	No Freeze-Thaw
	5	2	3	3	3	11	
	7	2	3	3	3	11	
Subgrade A-7-6	0	2	2	2	-	6	
	5	2	2	2	3	9	
	7	2	2	2	3	9	
Subgrade A-6	0	-	3	-	-	3	With Freeze-Thaw
	5	-	2	-	-	2	
	7	-	2	-	-	2	
Subgrade A-7-6	0	-	3	-	-	3	
	5	-	2	-	-	2	
	7	-	2	-	-	2	

Chapter 4 EFFECTS OF MOISTURE AND SUCTION ON LIME-STABILIZED SOILS

4.1 GENERAL

This chapter is dedicated to present the results and discussions of the resilient modulus, unconfined compressive strength and suction values of untreated and lime-treated subgrade soils at different moisture contents. Comparison among replicate samples and effects of associated parameters related to laboratory testing are presented.

Specific objectives of this chapter are:

- 1) Evaluate the improvement of resilient properties (resilient modulus) and strength (unconfined compressive strength) due to lime treatment;
- 2) Assess the effect of molding moisture in engineering properties of untreated and lime treated subgrade soils;
- 3) Determine the suction potentials (total, matric and osmotic) at different moisture state of lime treated soils and correlate the resilient modulus values with soil suction;
- 4) Incorporate suction to traditional stress dependent resilient modulus models and evaluate the effects of suctions in the soil constitutive models for MEPDG applications.

4.2 RESILIENT MODULUS TEST RESULTS

Average resilient modulus test results of replicate samples for different soil combinations are shown in Table 4.1 to Table 4.4. It is to be mentioned that generating consistent resilient modulus results are very difficult even among replicate samples in the laboratory because of potential variations introduced when reconstituting soils. However, average results are used to observe the effects of associated parameters on stiffness or strength of particular soils.

Moisture contents among replicate samples were maintained within 0.5%. As time between sample preparation and testing was 12 hours to overnight (except the 7 days curing period for lime stabilized soils), moisture content was measured at the end of the unconfined compressive strength test and reported as sample moisture content. As soil samples were covered with few layers plastic wrap after compaction, sample moisture contents were not lost more than 0.5% of compaction moisture content in any cases. All replicate sample results are listed in the appendix at the end.

4.2.1 Untreated Subgrade Soils

The resilient modulus test results using AASHTO T 307 load sequences in confined and unconfined states are given in Table 4.1. M_R values for untreated subgrade soils show consistent results for all cell pressures. Untreated A-6 and A-7-6 subgrade soil have M_R values in a range of 92-145 ksi (634-999 MPa) and 75-106 ksi (517-730 MPa), respectively, at OMC. However, typical MEPDG Level 3 resilient modulus values at optimum moisture state for A-6 and A-7-6 soils are reported to be 13.5-24 ksi (93-165 MPa) and 5-13.5 ksi (34.5-93 MPa) respectively. It is speculated that as past researches mostly conducted M_R test using external LVDTs, the measured

deformations were high and therefore they obtained very small M_R values. Thus high M_R values obtain from this study is reasonable and supported by other studies (Barksdale et al. 1997; Andrei, 2003). In addition, resilient modulus values not always increase with the confining pressure for same deviator stress. Detail effects of confining pressure on resilient modulus values are discussed later in this section.

Figure 4.1 graphically presents the M_R results with deviator stresses for untreated A-6 and A-7-6 soils at different moisture state (dry, opt and wet) and specific confining pressure (4 psi). It is clearly seen that A-6 subgrade soil has higher modulus values than A-7-6 soil in all moisture state. As A-7-6 soils (fat clay) have higher plasticity than A-6 soils (lean clay), these results are expected. Consistent with the literature for fine-grained cohesive subgrade soils, resilient modulus values decrease with the increase of deviator stress due to softening effect in soils at higher deviator stresses. Moreover, resilient modulus values are decreased considerably with wetness or increasing moisture contents within the soils which agrees the high sensitivity of clayey subgrade soils with moisture variation.

4.2.2 Lime Stabilized Subgrade Soils

Resilient modulus test was conducted with unconfined high stress sequences for lime stabilized soils. A-6 and A-7-6 subgrade soils were treated with 5% and 7% lime and compacted at OMC in 2.8 inch and 4 inch diameter mold. Samples were cured for 7 days in accelerated manner (Little, 2000) and average M_R test results are presented in Table 4.2. Figure 4.2 presents the resilient modulus plot with deviator stress for 7% lime treated A-7-6 soil of both replicate sample sizes. Higher variance in resilient modulus results are observed for 2.8 inch than 4 inch replicate

samples, thus 4 inch diameter samples were prepared and tested for all other cases in this study. Effects of the sample size on the resilient modulus test results are focused later.

Table 4.3 and 4.4 summarize the results of A-6 and A-7-6 subgrade soils treated with 5% and 7% lime and compacted at different moisture contents (dry, opt and wet). Samples were 4 inch diameter and cured for 7 days before the M_R test. Resilient modulus results are graphically showed with deviator stresses in Figure 4.3 and 4.4, respectively, for lime stabilized A-6 and A-7-6 soils. Similar with untreated soils, resilient modulus values decrease with increasing deviator stress for wet and optimum state samples of lime stabilized A-6 soils and all moisture state of A-7-6 soils. Only the dry moisture state of lime stabilized A-6 soil shows an increase of M_R value with deviator stress increment. It is an unusual phenomena and difficult to explain. This indicates that A-6 soils behave like granular aggregate due to lime treatment at dry state.

It was established that resilient modulus values increased due to lime-stabilization from all past literatures (Little 2012). Table 4.1 to Table 4.4 support the mentioned statement but the increment varies with soil types and lime doses. M_R values for A-6 soils stabilized with 5% and 7% lime are in the range of 450-715 ksi (3100-4930 MPa) and 800-1100 MPa (5520-7585 MPa) respectively. For A-7-6 soils, these values are 560-870 ksi (3860-6000 MPa) and 300-510 ksi (2070-3520 MPa) due to 5% and 7% lime treatment respectively. Thus, A-6 subgrade soil becomes stiffer in all lime percentages for this study, but reduction in resilient modulus is observed for A-7-6 soil at 7% lime dose. This result justifies other studies (Osinubi and Nwaiwu 2006, Solanki et al. 2009). Possible explanation for that is excess lime behaved as low strength filler and effectively weakened the lime-soil mixture (Osinubi and Nwaiwu 2006).

4.3 UNCONFINED COMPRESSIVE STRENGTH TEST RESULTS

Unconfined compressive strength (UCS) test was performed on two types of sample using universal testing program. All samples which were subjected to M_R tests were failed using unconfined compression is named as M_R tested samples. Separately, 5% lime treated A-6 soils compacted at OMC and cured for 7 days were tested only unconfined compressive strength is termed as virgin samples. Comparative UCS results of virgin and M_R tested 2.8 inch and 4 inch samples same soil type is summarized in Table 4.5. Similar with M_R results, higher variance is observed for 2.8 inch sample compare to 4 inch sample. Thus repeatability of results is concerned for 2.8 inch diameter samples. For 4 inch diameter specimens, it is seen that M_R tested samples exhibited slightly higher UCS values than virgin samples (Table 4.5). This is due to the fact that resilient modulus test can make the samples stronger due to preloading (Khoury 2002). Figure 4.5 presents the stress-strain curve of 5% lime treated A-6 virgin soil samples. As seen from Figure 4.5, lime treated samples failed within 2% of strain increment which was common to all treated samples of this study. In comparison, untreated soils were failed not before reaching 10% strain in UCS test. Figure 4.6 depicts the typical failure pattern of untreated and lime-treated subgrade soils. Untreated subgrade soils (Figure 4.6a) commonly bulged due to unconfined compression, treated subgrade soils (Figure 4.6b) crushed like concrete at failure point.

Table 4.6 summarizes UCS test results of untreated and lime treated M_R tested samples. Following similar trends of resilient modulus results, UCS value increases due to lime addition except with 7% lime dose for A-7-6 soil. Moreover, UCS increases with the decrement of moisture content for all soil types.

4.4 SOIL SUCTION TESTS

Soil suction measurement technique, filter paper method, is based on the assumption that water potential of a soil sample is the same as the water potential of a specified filter paper when they are equilibrium. Whatman No.42 filter paper was used in this study which has predefined manufacturer calibration curve to estimate the soil suction indirectly from the filter paper water content after equilibrium. Total and matric suctions were determined on samples compacted at three different moisture states (dry, optimum and wet). Osmotic suction was calculated from the difference between these two suctions. All suction results are summarized in Table 4.7. Figure 4.7 and 4.8 are presented graphically the total and matric suction with water content for A-6 and A-7-6 soils respectively. It is seen that total and matric suction increase due to decrease in moisture content. High matric suction implies high capillary stresses in soils and causes movement or flow of water in an unsaturated state, which results in increase in water content in the subgrade layer after construction (Yang et al. 2005). For A-6 soils, total suction of 378 psi (2609 kPa) and 710 psi (4901 kPa) are obtained for 0% and 5% lime dose, respectively, at 17.7% moisture content (Table 4.7). Similarly, matric suction value increases due to lime addition in the soil. Pozzolanic reaction of water and lime particles generates crystalline fine particles that decrease the plasticity of clayey soils (Khoury et al. 2003). Fine particles increase the adhesion/cohesion capacity in the lime stabilized soils, thus attracts more water than untreated soils counterpart. Addition of lime increases the salt potential which implies the increase of osmotic suction in lime stabilized clayey subgrade soils.

4.5 DISCUSSION OF TEST RESULTS

Effects of associated parameters on laboratory test results are discussed in this segment.

4.5.1 Effects of Confining Pressure

Effects of confining pressure on resilient modulus values are reported for untreated raw soil. An unconfined test was done with the same deviator stress sequences prior to testing with AASHTO T 307 sequences. Resilient modulus values for the same deviator stresses are compared to one another as percent difference between 2 to 6 psi, 0 to 4 psi and 0 to 6 psi confining pressure relative to the lowest confining pressure M_R values. Comparison is done for both A-6 and A-7-6 soils and demonstrated in Table 4.8. A sample equation to compare the resilient modulus values corresponding to 6 psi with respect to 0 psi confining pressure is shown below:

$$\% \text{ difference of } M_R \text{ between 0 to 6 psi CP} = \frac{M_R (0 \text{ psi}) - M_R (6 \text{ psi})}{M_R (0 \text{ psi})} \times 100 \quad (4.1)$$

Table 4.1 shows that the differences in resilient modulus values due to the change in confining pressure are small. It supports studies that cohesive fine-grained samples are not significantly affected by small confining pressures. Table 4.8 has the evidence that the average difference in resilient modulus values relative to low confining pressure shows less than 10% change in all cases. Thus it can be concluded that confining pressure has a small effect on resilient modulus values of subgrade soils.

4.5.2 Effects of Sample Size

To compare the effects of available sample size on resilient modulus results, it was decided to reconstitute the lime-stabilized optimum moisture state sample by having a 2.8 inch diameter and observe the difference in resilient modulus results with 4 inch diameter sample. Table 4.2 shows average M_R test results are close for different sample sizes at different soil combinations. However, Table 4.9 demonstrates the difficulties to obtain consistent test results with the 2.8 inch diameter sample. Coefficient of variance (COV) is calculated among replicate samples for each deviator stress case. COV is a normalized measure of dispersion of a probability distribution and calculated as the ratio of standard deviation to the mean. COV calculated for 2.8 inch diameter sample is always much higher than the 4 inch diameter sample (Table 4.9).

For this study, unconfined compressive strength test of virgin samples has maximum number of replicates (6 samples). Lack of repeatability in 2.8 inch samples was ensured by UCS test results in Table 4.5. It is seen that COV among 2.8 inch replicate samples (16.7) is larger than 4 inch diameter samples (5.9). Probable reason for this is the side-wall restraint effect of the 2.8 inch sample due to an insufficient surface area for modified proctor hammering (Cabrera 2012). The 4 inch diameter sample can overcome this limitation and ensure the reproducibility of test results.

4.5.3 Effects of Lime Content

It is obvious that the resilient modulus and UCS value increases due to lime stabilization. For comparison purpose, 10 psi deviator stress with zero confining pressure is chosen as only this value is common for two different test sequences of untreated and lime-treated soil. Figure 4.9 to Figure 4.11 depict the effect of lime addition on stiffness (resilient modulus) and strength (UCS)

of subgrade soils among optimum moisture state samples. 5% lime addition increases M_R values approximately 600% and 1000% in A-6 and A-7-6 soils respectively. However, 7% lime dose decreases M_R value to 41% from 5% lime dose in A-7-6 soil. Similarly, 250% and 352% increment of UCS value are seen for 5% and 7% lime dose, respectively, in A-6 soil. Again, 7% lime addition in A-7-6 soil causes 16% decrease in UCS value from that of 5% lime dose. Thus, it can be concluded that 5% lime is the design optimum lime content of A-7-6 soil, whereas for A-6 soil it may be 7% or more, which is not being able to determine exactly from this study.

Figure 4.12 shows the osmotic proportion in total suction value for lime treated soils. Obviously, lime addition impacts the suction value. Due to the presence of lime, a chemical reaction occurs between the soil particles and clay minerals, which increases the value of suction in the lime treated soils. Though osmotic suction has been reported to hold negligible effect in total suction (Fredlund and Rahardjo 1993), this study reveals that the proportion of osmotic suction in total suction increases about 15% due to lime addition, which can be seen in both cases of lime treated A-6 and A-7-6 soils.

4.5.4 Effects of Molding Moisture

Though construction specification mostly requires compacting pavement subgrade at OMC with more than 90% of MDD, subgrade soils are subjected to seasonal variation of moisture (Yang et al. 2005). Furthermore, lime-stabilized subgrade soil is considered as moisture-insensitive thus the variation of resilient modulus and UCS of clayey subgrade soil is significantly minimized due to moisture changes. This study examines the change in M_R or UCS value with respect to optimum moisture for both untreated and lime-treated subgrade soils. Average water content

among replicate samples in this study was maintained within $\pm 2-3\%$ of optimum water content. Percent difference in M_R results due to different moisture states from optimum are calculated using Eq. 4.2 and 4.3.

$$\% \text{ difference of } M_R \text{ in dry state} = \frac{\text{Dry } M_R - \text{Optimum } M_R}{\text{Optimum } M_R} \times 100 \quad (4.2)$$

$$\% \text{ difference of } M_R \text{ in wet state} = \frac{\text{Wet } M_R - \text{Optimum } M_R}{\text{Optimum } M_R} \times 100 \quad (4.3)$$

Figure 4.13 and 4.14 demonstrate the percent differences of resilient modulus and UCS between dry and wet state results from optimum for all subgrade soil combination. For resilient modulus, value of 10 psi deviator stress sequence is compared. It is clear that moisture affects the M_R and UCS of lime-treated soil, but influence of moisture minimizes in comparison to untreated subgrade soils. About 22% and 42% reduction in M_R value can be seen from Figure 4.13 for A-6 with 7% lime and A-7-6 with 5% lime respectively. Moreover, variation of M_R with moisture decreases drastically due to the addition of lime in A-6 soil than that in A-7-6 soils.

4.5.5 Resilient Modulus with Soil Suction

Figure 4.15 shows variation of resilient modulus with different suction components obtained at different moisture contents. Results for different soil types are plotted together to understand the overall correlations among M_R and total, matric and osmotic suctions. It is found that M_R increases with an increase in soil suctions. Increase in M_R values can be recognized to the fact that the dry state of soil initiated high suction in the soil. Thus integrity of soil structure and rigidity of soil skeleton are enhanced. Therefore higher suction stiffens the soil specimen, resulting in higher M_R compared to M_R at low suction value.

It is clear the change in resilient modulus among suction components is similar. As Figure 4.15 is plotted for different soils tested in this study, good correlation is not expected. However, osmotic suction correlates better with M_R over other suction components. Therefore, osmotic suction cannot be ignored in M_R constitutive models of lime treated soils. This study makes an effort to incorporate suction in the existing M_R model used in MEPDG.

4.6 RESILIENT MODULUS MODELS WITH SUCTION

Different predictive models of M_R are available in pavement literature. Most of them are based on state of stress (Titi et al. 2006). Three models are considered in the current study for incorporation of suction is briefly described below:

Model 1 (stress state): This model is generalized log-log model recommended by MEPDG level-1 design inputs for unbound materials which was described in Eq. 2.8.

$$M_R = k_1 P_a \left(\frac{\theta}{P_a} \right)^{k_2} \left(\frac{\tau_{oct}}{P_a} + 1 \right)^{k_3} \quad (4.4)$$

Where: P_a = atmospheric pressure (101.3 kPa), θ = bulk stress (sum of three principal stresses), τ_{oct} = octahedral shear stress = $\frac{\sqrt{2}}{3} \sigma_d$ (for laboratory triaxial condition), σ_d = cyclic deviator stress and k_1, k_2, k_3 are regression constants.

For laboratory confined M_R test (untreated subgrade soil case), bulk stress is defined as $\theta = \sigma_d + 3 \sigma_3$; where σ_3 is the confining pressure. Therefore bulk stress is same as deviator stress in case of unconfined M_R test.

Model 2 (stress state and suction): This model is borrowed from Liang et al. (2008) by incorporating total suction in above MEPDG model. Basic concept is generated from effective stress relationship proposed by Bishop (1959).

$$\sigma' = (\sigma - u_a) + \chi_w \times (u_a - u_w) \quad (4.5)$$

where: σ' = effective stress; σ = total stress; χ_w = Bishop's parameter; u_a and u_w are pore air and water pressure respectively.

In Eq. 4.5, $(u_a - u_w)$ parameter is the effective stress contributed by suction, which is termed as matric suction as well (Yang et al. 2005, Liang et al. 2008). This study reveals the proportion of osmotic suction in lime treated soils increases with lime addition. Thus, total suction is considered in place of matric suction. Bishop's parameter is a function of degree of saturation (zero for dry soil and one for wet soil), which is commonly used as weight of matric suction on effective stress. In this study, full contribution from total suction is assumed ($\chi_w = 1$) and pore air pressure is considered to be $u_a = 0$. Combining Eq. 4.4 and 4.5, predictive equation of M_R incorporating both stress state and suction takes the following form:

$$M_R = k_1 P_a \left(\frac{\theta + \psi_T}{P_a} \right)^{k_2} \left(\frac{\tau_{oct}}{P_a} + 1 \right)^{k_3} \quad (4.6)$$

Where: ψ_T and M_R are the total soil suction and resilient modulus measured at optimum moisture content respectively.

Model 3 (stress, suction and moisture state): Coefficients (k's) for this model are calculated by regression analysis using M_R and suction test results for different moisture states (dry, optimum and wet). Thus, influence of stress state, total suction and moisture condition in M_R values are accounted when Model 3 is adopted.

In the current study, multiple linear regression analysis is performed to find k_1, k_2, k_3 values. Table 4.10 presents the regression constants for different soil combinations. Models are evaluated based on multiple correlation coefficients (R^2) and percent of error among predicted and measured M_R values. MEPDG design guide recommends a R^2 value 0.9 or greater to ensure good predictability of constitutive models. From Table 4.10, it can be seen that all combination of soils exhibit good correlation fit using Model 1 and Model 2 with only optimum moisture state test results. Though Model 3 captures M_R data for all moisture states, it shows comparatively lower prediction capability ($R^2 > 0.85$) than other models. Thus M_R results at different moisture state (dry/wet) does not improve the prediction capability of M_R models over only optimum moisture state test results. Small percent error of predicted and laboratory measured M_R value is obtained for all three models. It is clear that total suction incorporation in Model 2 shows improvement over predictions by Model 1. Thus Model 2 is a good alternative of stress-dependent MEPDG model for predicting M_R . Moreover, incorporating total suction in M_R model provides added advantage in demonstrating moisture variation in clayey subgrade soils.

4.7 SUMMARY

In this chapter, resilient modulus, unconfined compressive strength and suction tests results are presented and discussed for untreated and lime treated A-6 and A-7-6 subgrade soils compacted at dry, optimum and wet moisture states. Summary findings are:

- Engineering properties (M_R and UCS value) are improved due to lime treatment in New Mexico clayey subgrade soils. Resilient properties increase 6 and 9.6 times due to 5% and 7% lime addition to A-6 soils. A-7-6 soils exhibit 10 times improvement at 5% lime dose, but M_R decreases for higher application (7%). Similar trend has been observed in UCS values.
- M_R and UCS values increase with the decrease in molding moisture and deviator stress for untreated and lime-treated subgrade soils. Lime addition can reduce the moisture sensitivity of resilient modulus and UCS value of untreated clayey subgrade soils.
- All suction components (total, matric and osmotic) increase due to lime addition in raw subgrade soils. M_R value increases with soil suction. Osmotic suction increases about 15% of total suction due to lime treatment for both A-6 and A-7-6 soils. Osmotic suction correlates better with resilient modulus values.
- As both suction components (matric and osmotic) has substantial contribution in suction, total suction is incorporated in the stress dependent M_R model and obtain better predictability of M_R values for clayey subgrade soils.

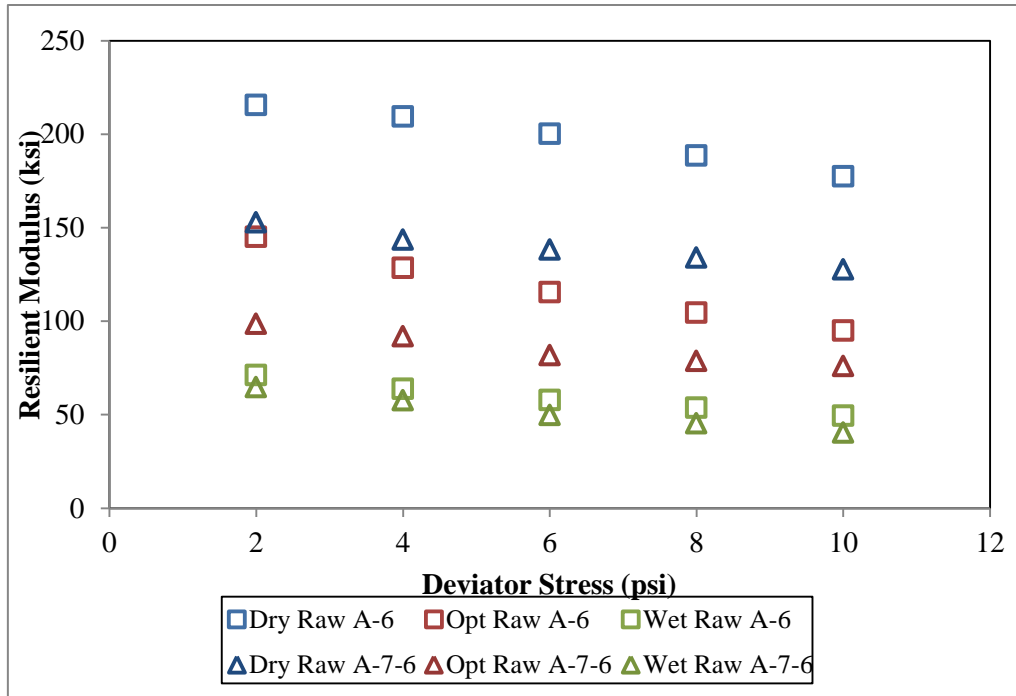

Figure 4.1 Resilient Modulus Plot with Deviator Stress for Untreated Subgrade in All Moisture State (Confining Pressure 4 Psi)

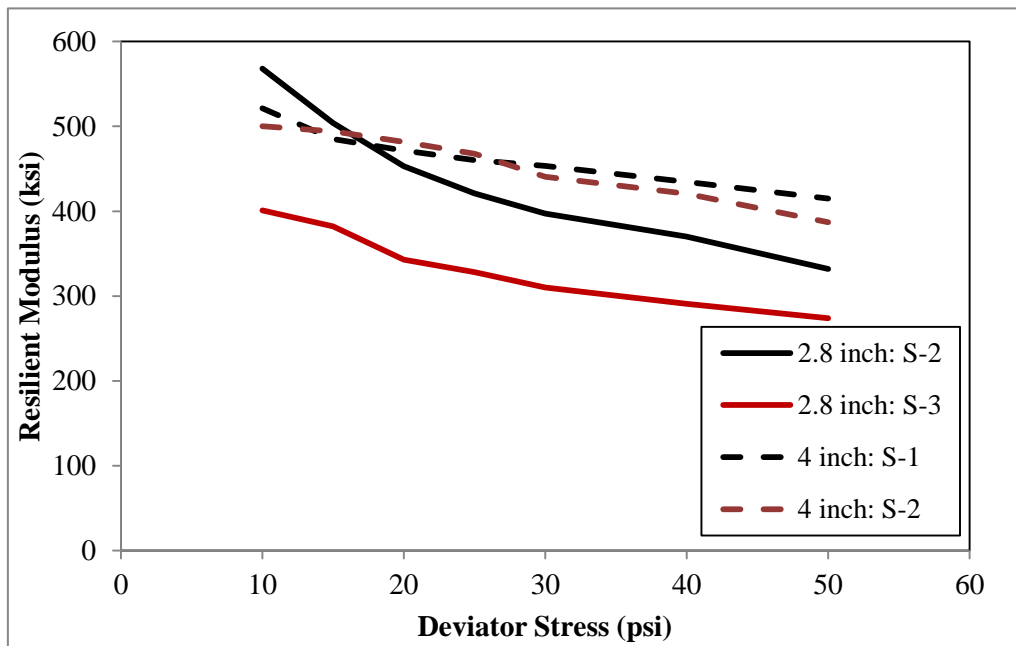

Figure 4.2 Resilient Modulus Variation among Sample Sizes for 7% Lime Treated A-7-6 Soil

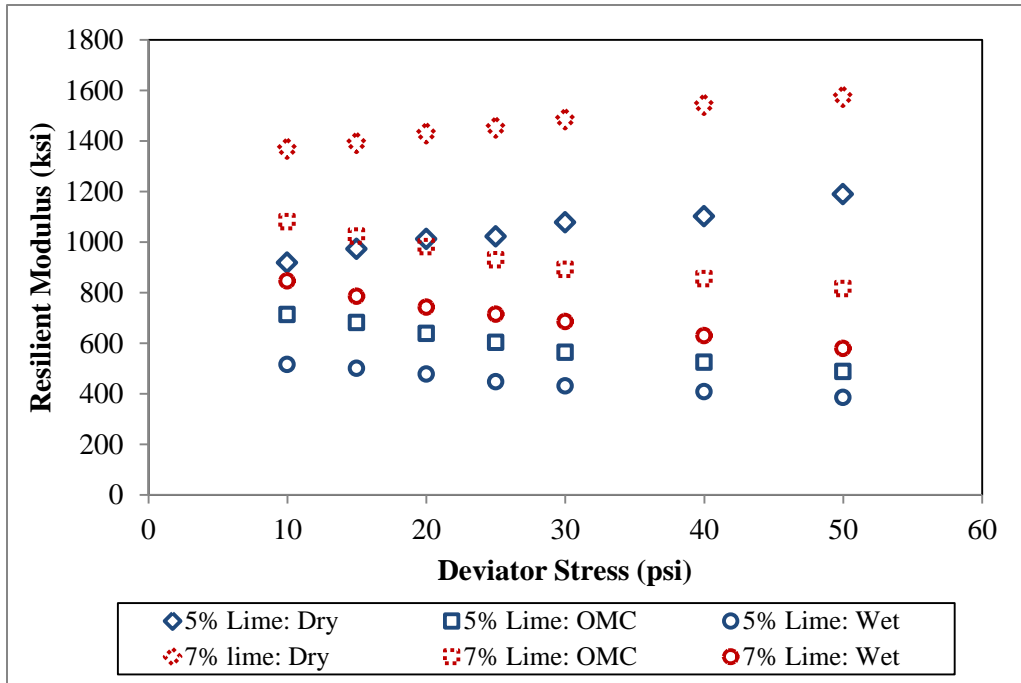

Figure 4.3 Resilient Modulus Plot for Lime Treated A-6 Subgrade Soils

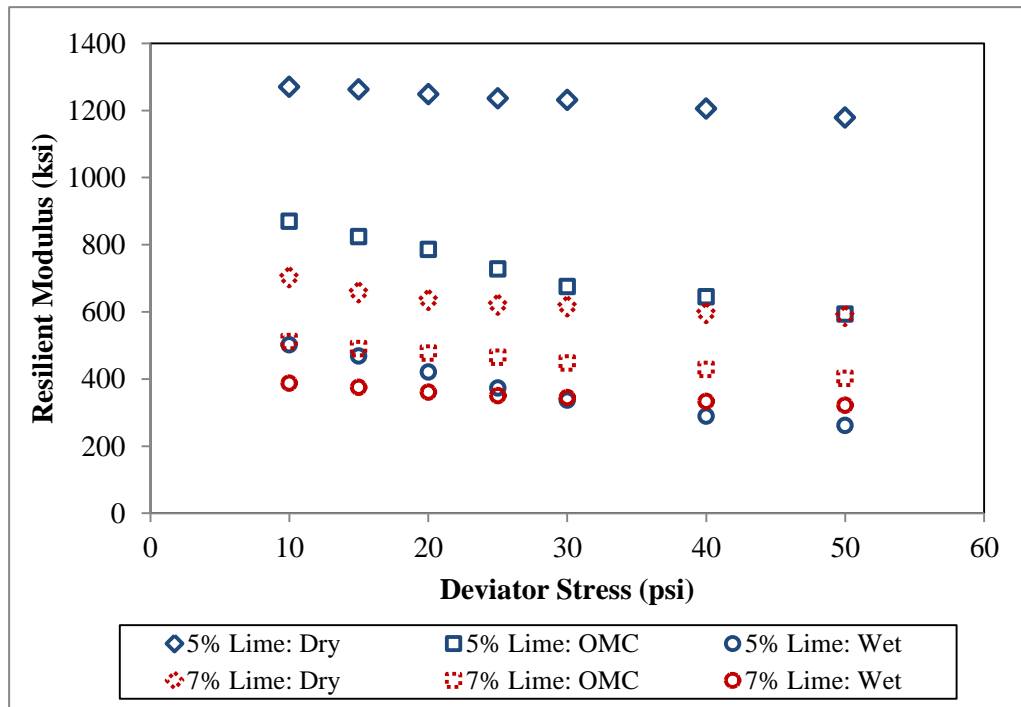

Figure 4.4 Resilient Modulus Plot for Lime Treated A-7-6 Subgrade Soils

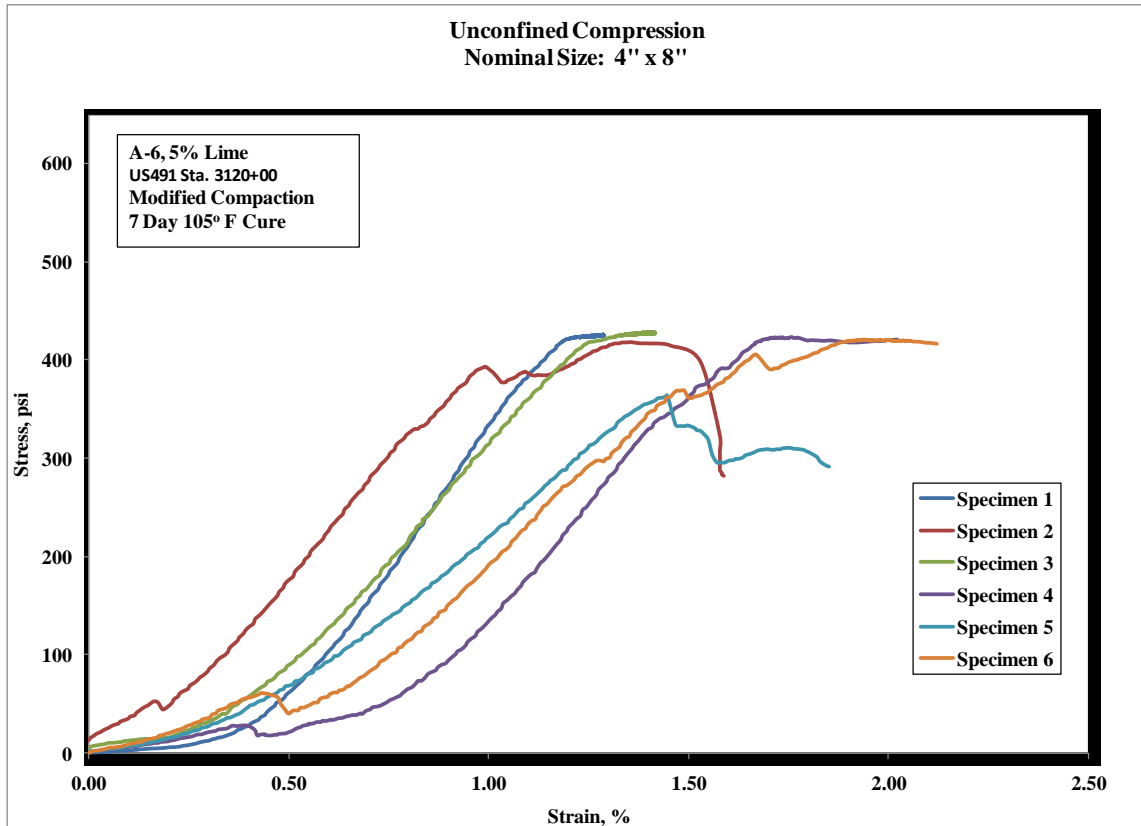

Figure 4.5 Stress-Strain Plot for 5% lime Treated A-6 Virgin Samples under Unconfined Compression



Figure 4.6 Typical Failure Pattern in Soils after Unconfined Compression Failure

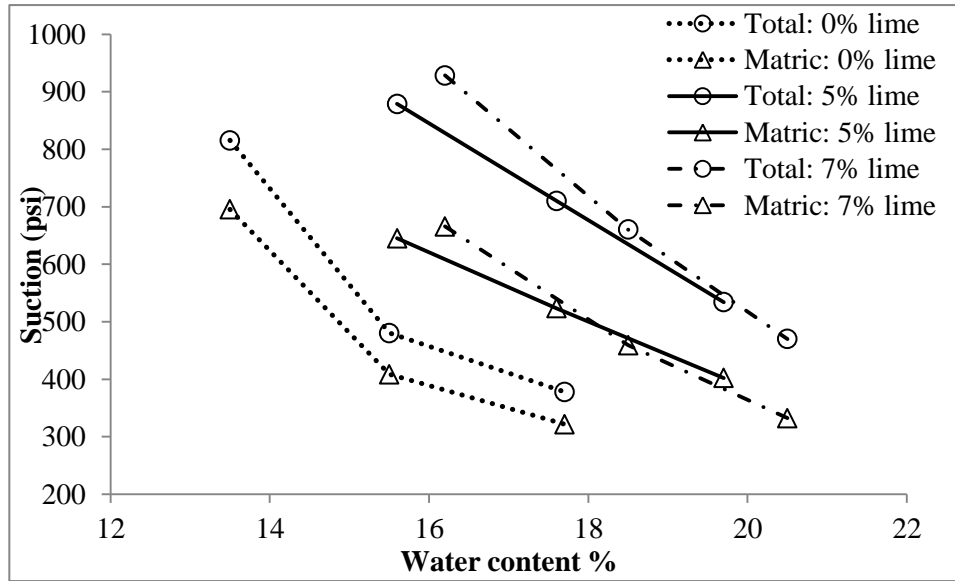

Figure 4.7 Total and Matric Suctions with Water Contents for A-6 Soils

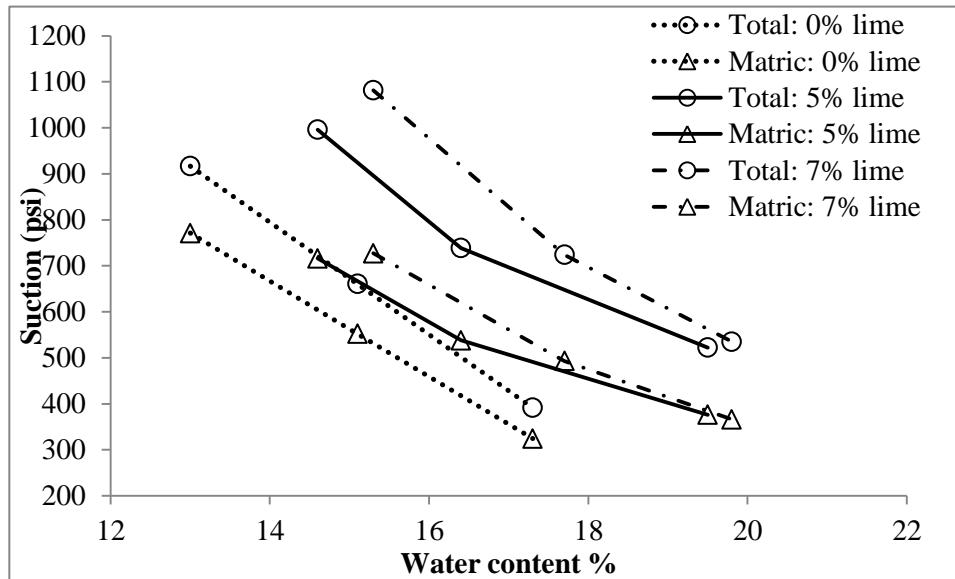

Figure 4.8 Total and Matric Suctions with Water Contents for A-7-6 Soils

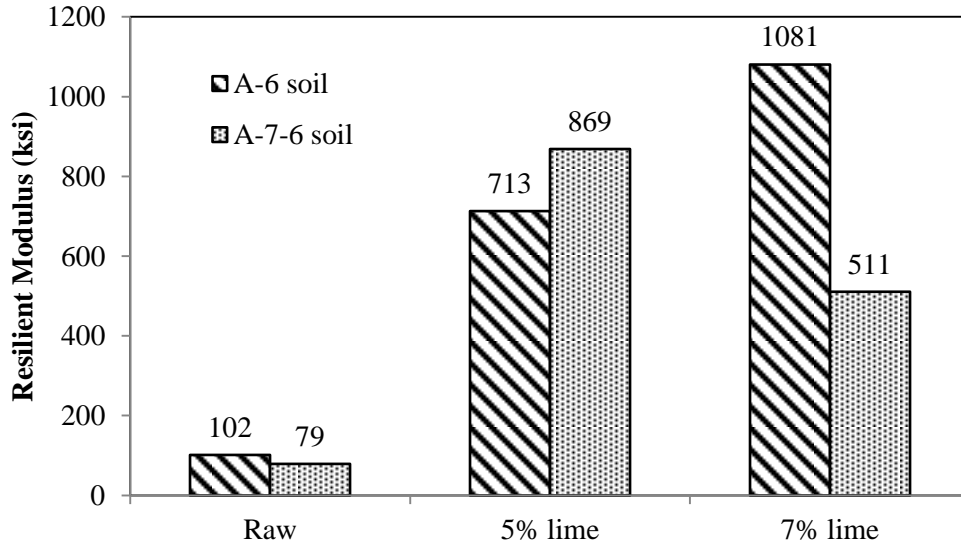

Figure 4.9 Variation of Resilient Modulus with Soil and Lime Dose (SD =10 Psi, CP = 0 Psi)

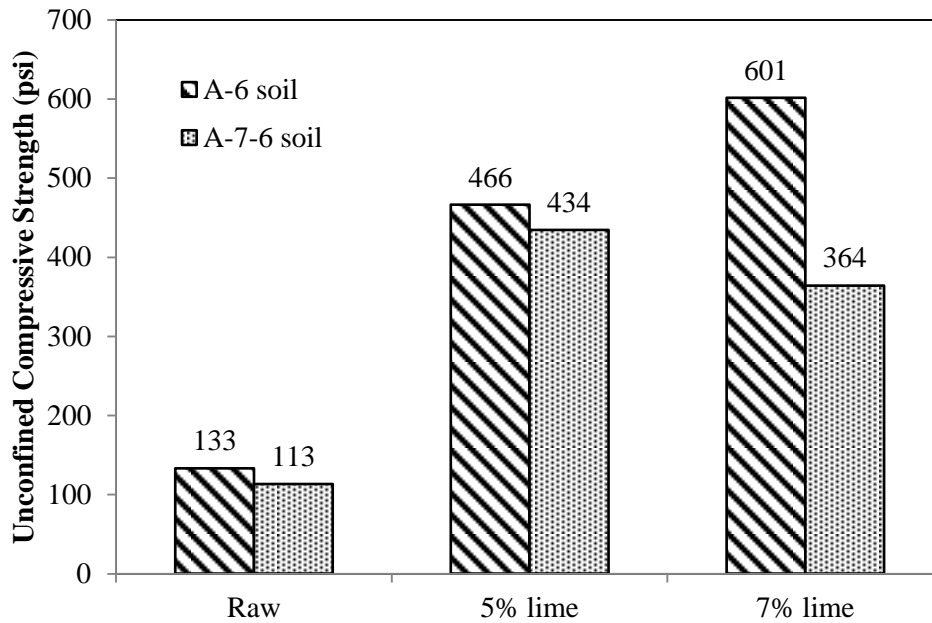

Figure 4.10 Variation of Unconfined Compressive Strength with Soil and Lime Dose

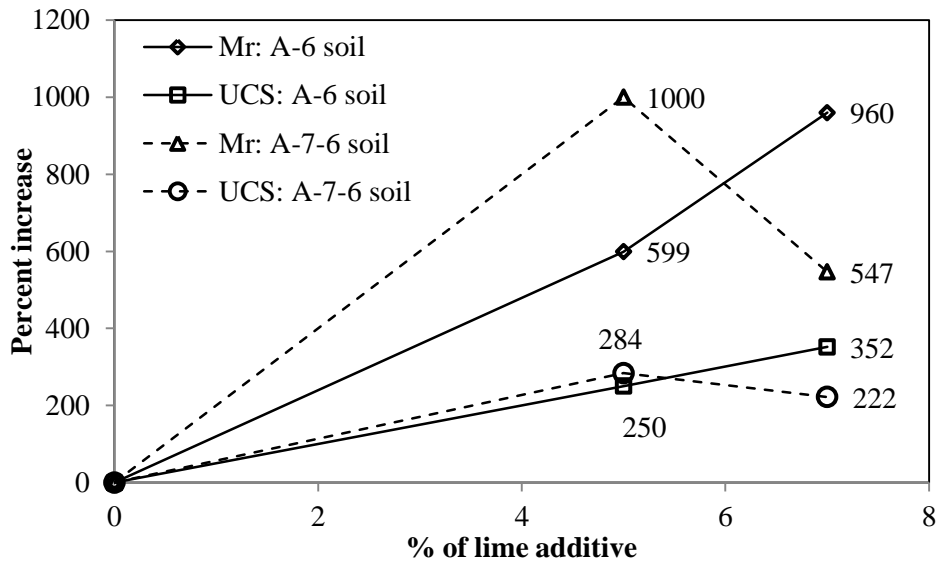

Figure 4.11 Percent Increment of Resilient Modulus and UCS with Soil and Lime Dose

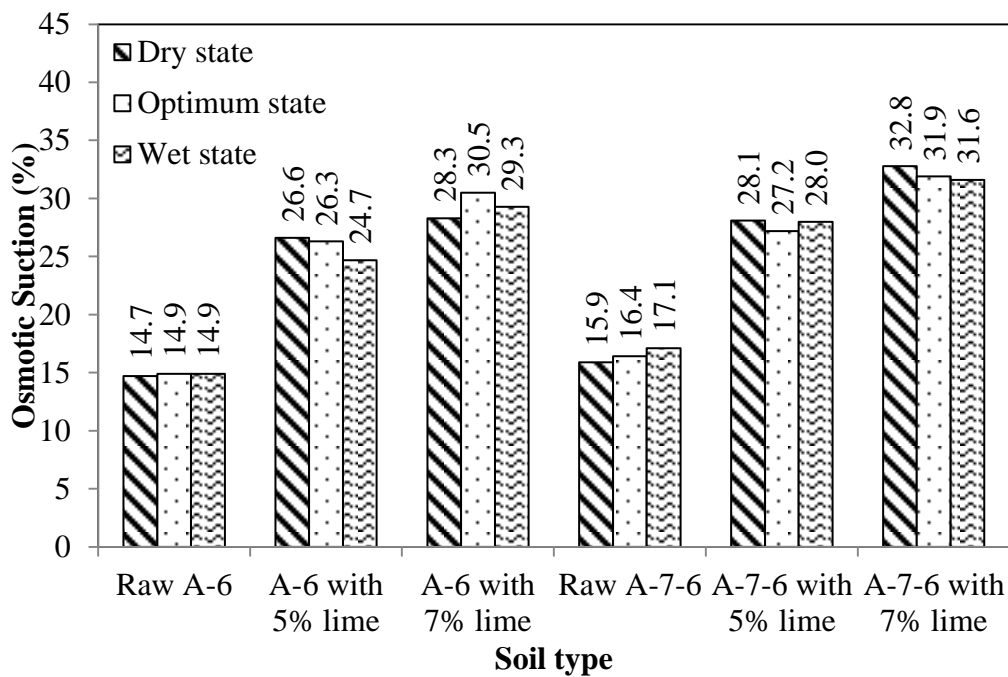

Figure 4.12 Proportion of Osmotic Suction in Total Suction due to Lime Treatment

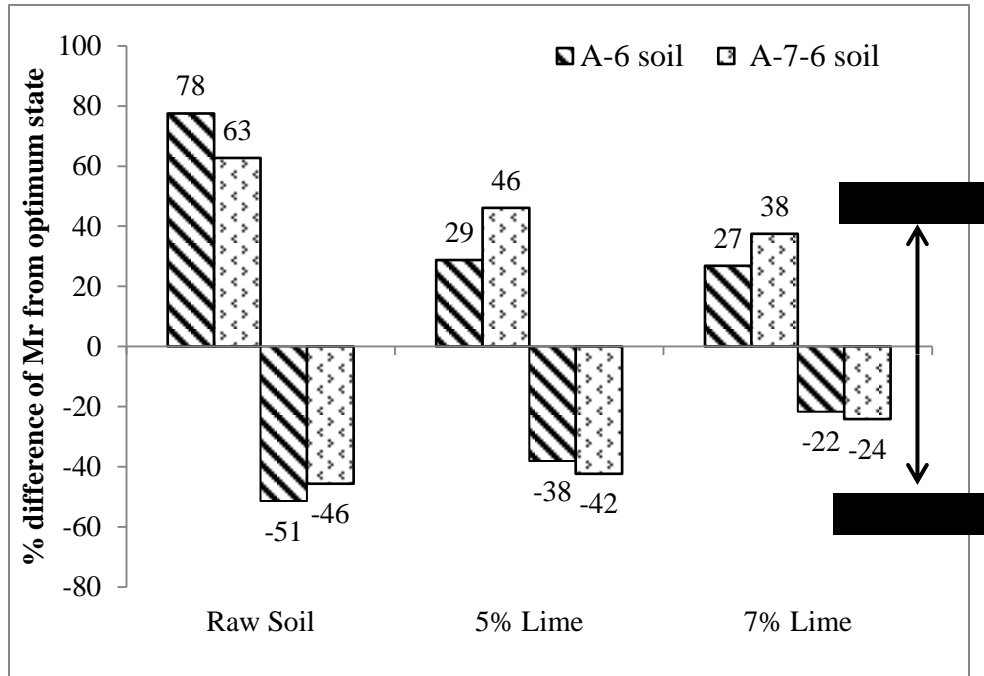

Figure 4.13 Percent Difference from Optimum Moisture in Resilient Modulus Results

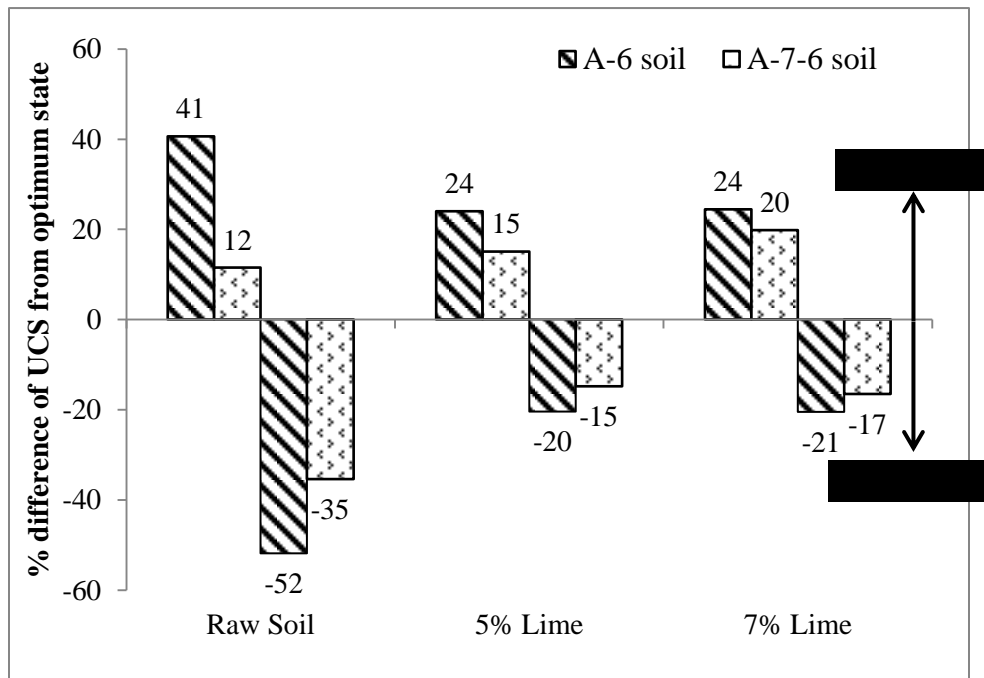

Figure 4.14 Percent Difference from Optimum Moisture in UCS Results

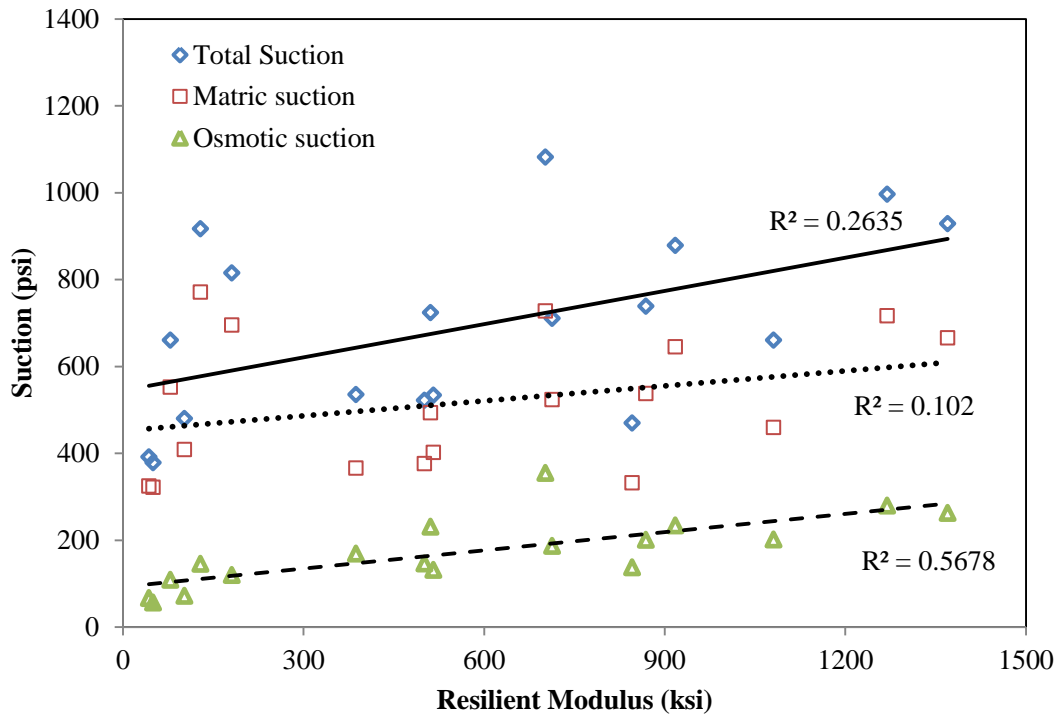

Figure 4.15 Suction with Resilient Modulus for all Soils

Table 4.1 Average Resilient Modulus for Untreated Subgrade Soils at All Moisture State

Cell Pressure (psi)	Deviator stress (psi)	Max Cyclic Stress (psi)	Raw A-6			Raw A-7-6		
			Dry	Opt	Wet	Dry	Opt	Wet
			w=13.5%	w=15.5%	w=17.7%	w=13.0%	w=15.1%	w=17.3%
			M_R (ksi)					
6	2	1.8	217	143	71	150	103	64
6	4	3.6	207	128	66	144	99	57
6	6	5.4	197	112	60	140	85	49
6	8	7.2	186	101	56	136	79	45
6	10	9	174	92	52	129	75	40
4	2	1.8	216	145	71	153	99	65
4	4	3.6	209	129	64	144	92	58
4	6	5.4	200	115	58	138	82	50
4	8	7.2	189	105	54	134	79	45
4	10	9	178	95	50	128	76	40
2	2	1.8	215	141	70	153	97	64
2	4	3.6	210	132	63	145	96	56
2	6	5.4	201	116	57	139	85	50
2	8	7.2	189	104	52	133	82	44
2	10	9	178	94	48	128	78	39
0	2	1.8	216	144	72	156	106	66
0	4	3.6	209	133	66	149	101	58
0	6	5.4	201	120	60	142	91	52
0	8	7.2	191	108	55	134	85	47
0	10	9	181	102	50	129	79	43

Note: 1 ksi = 6.89 MPa; 1 psi = 6.89 kPa; M_R = Resilient Modulus; w = Moisture Content after UCS testing; Dry, Opt, Wet = Sample Moisture States; Opt = Optimum Moisture Content

Table 4.2 Average Resilient Modulus For Lime-Treated Subgrade Soil For Two Different Sample Sizes

Deviator Stress (psi)	A-6 with 5% lime		A-6 with 7% lime		A-7-6 with 5% lime		A-7-6 with 7% lime	
	Optimum state		Optimum state		Optimum state		Optimum state	
	2.8"x5.6"	4"x8"	2.8"x5.6"	4"x8"	2.8"x5.6"	4"x8"	2.8"x5.6"	4"x8"
	M_R (ksi)							
10	715	713	1122	1092	853	869	475	511
15	685	666	1088	1016	790	824	435	490
20	653	611	1057	966	726	785	392	477
25	629	564	1014	905	700	727	372	464
30	605	514	978	870	675	675	353	447
40	560	479	923	841	622	645	333	427
50	485	448	881	802	565	593	297	401

Note: 1 ksi = 6.89 MPa; 1 psi = 6.89 kPa; M_R = Resilient Modulus

Table 4.3 Average Resilient Modulus For Lime-Treated A-6 Soil At All Moisture States

Deviator Stress (psi)	Max Cyclic Stress (psi)	A-6 with 5% lime			A-6 with 7% lime		
		Dry	Opt	Wet	Dry	Opt	Wet
		w=15.6%	w=17.6%	w=19.7%	w=16.2%	w=18.5%	w=20.5%
		M_R (ksi)					
10	9	918	713	516	1370	1081	846
15	13.5	974	682	500	1392	1024	785
20	18	1012	638	478	1430	982	743
25	22.5	1023	603	448	1452	930	715
30	27	1077	564	432	1485	892	686
40	36	1102	525	409	1543	855	630
50	45	1189	488	385	1574	816	579

Note: 1 ksi = 6.89 MPa; 1 psi = 6.89 kPa; M_R = Resilient Modulus; w = Moisture Content after UCS testing; Dry, Opt, Wet = Sample Moisture States; Opt = Optimum Moisture Content

Table 4.4 Average Resilient Modulus For Lime-Treated A-7-6 Soil At All Moisture States

Deviator Stress (psi)	Max Cyclic Stress (psi)	A-7-6 with 5% lime			A-7-6 with 7% lime		
		Dry	Opt	Wet	Dry	Opt	Wet
		w=14.6%	w=16.4%	w=19.5%	w=16.2%	w=18.5%	w=20.5%
		M_R (ksi)					
10	9	1270	869	501	702	511	387
15	13.5	1262	824	468	657	490	375
20	18	1248	785	420	635	477	361
25	22.5	1235	727	373	621	464	350
30	27	1230	675	336	616	447	344
40	36	1205	645	289	596	427	333
50	45	1179	593	261	587	401	321

Note: 1 ksi = 6.89 MPa; 1 psi = 6.89 kPa; M_R = Resilient Modulus; w = Moisture Content after UCS testing; Dry, Opt, Wet = Sample Moisture States; Opt = Optimum Moisture Content

Table 4.5 UCS Results of Virgin and M_R Tested 5% Lime-Treated A-6 Soil Samples

Sample Size	4" x 8"		2.8" x 5.6"	
Sample Type	Virgin	M_R tested	Virgin	M_R tested
Sample No	UCS (psi)			
1	426	446	451	382
2	415	448	437	372
3	428	483	407	421
4	424	-	422	-
5	364	-	487	-
6	421	-	621	-
Average	413.0	459.0	470.8	391.7
SD	24.4	20.8	78.5	25.9
COV (%)	5.9	4.5	16.7	6.6

Note: UCS = Unconfined Compressive Strength; M_R = Resilient Modulus; SD = Standard Deviation, COV = Coefficient of Variance

Table 4.6 Average Unconfined Compressive Strength Results For Untreated And Lime-Treated Subgrade Soils

Type of soil	% of lime additive	Average UCS (psi)		
		Dry	Opt	Wet
A-6	0	187	133	64
	5	578	466	371
	7	692	601	512
A-7-6	0	126	113	73
	5	540	434	345
	7	436	364	304

Note: UCS = Unconfined Compressive Strength; Dry, Opt, Wet = Sample Moisture States; Opt = Optimum Moisture Content

Table 4.7 Soil Suction Results for All Soil Types Using Filter Paper Method

Soil Type	% Lime	Moisture Condition	%w	Total Suction (psi)	Matric Suction (psi)	Osmotic Suction (psi)	% of osmotic suction
A-6	0	Dry	13.5	815	696	120	14.7
		Opt	15.5	480	409	72	14.9
		Wet	17.7	378	322	56	14.9
	5	Dry	15.6	879	645	234	26.6
		Opt	17.6	710	523	187	26.3
		Wet	19.7	534	402	132	24.7
	7	Dry	16.2	928	666	263	28.3
		Opt	18.5	661	459	201	30.5
		Wet	20.5	470	332	138	29.3
A-7-6	0	Dry	13	917	771	146	15.9
		Opt	15.1	661	552	108	16.4
		Wet	17.3	391	324	67	17.1
	5	Dry	14.6	996	716	280	28.1
		Opt	16.4	739	538	201	27.2
		Wet	19.5	522	376	146	28.0
	7	Dry	15.3	1082	727	354	32.8
		Opt	17.7	724	493	231	31.9
		Wet	19.8	535	366	169	31.6

Table 4.8 Effects Of Confining Pressure On Resilient Modulus Test Results Of Untreated Subgrade Soils

Deviator stress (psi)	Raw A-6 soil			Raw A-7-6 soil		
	% Difference in M_R			% Difference in M_R		
	2 to 6 psi	0 to 4 psi	0 to 6 psi	2 to 6 psi	0 to 4 psi	0 to 6 psi
2	-1.61	-0.76	0.74	-5.40	7.03	3.30
4	2.97	3.04	3.77	-3.61	8.93	1.98
6	3.20	4.02	6.93	-0.24	9.56	5.80
8	2.70	3.54	6.77	3.02	6.86	6.06
10	1.32	6.96	9.44	3.73	3.80	5.38
Average	1.71	3.36	5.53	-0.50	7.24	4.50

Table 4.9 Sample Size Comparison Using Resilient Modulus Results

Deviator Stress (psi)	A-6 with 5% lime		A-6 with 7% lime		A-7-6 with 5% lime		A-7-6 with 7% lime	
	Optimum state		Optimum state		Optimum state		Optimum state	
	2.8" x 5.6"	4" x 8"	2.8" x 5.6"	4" x 8"	2.8" x 5.6"	4" x 8"	2.8" x 5.6"	4" x 8"
	COV (%)	COV (%)	COV (%)	COV (%)	COV (%)	COV (%)	COV (%)	COV (%)
10	10.07	1.36	0.80	1.76	10.18	4.44	17.88	2.93
15	8.19	2.45	2.20	2.25	8.22	4.43	14.38	1.31
20	8.07	4.60	5.08	2.28	6.61	4.54	14.24	1.52
25	7.03	7.04	6.32	5.19	8.81	5.43	12.53	1.15
30	6.35	9.88	7.59	6.59	9.87	4.08	12.31	2.00
40	3.57	10.15	10.55	3.50	8.75	3.32	11.93	2.31
50	8.42	9.61	9.75	2.55	7.27	3.04	10.45	4.91
Average	7.39	6.44	6.04	3.45	8.53	4.18	13.39	2.30

Note: COV = Coefficient of Variance

Table 4.10 Summary of Resilient Modulus Constitutive Models

Soil Type	Model No	Regression constants			R ²	M _R (ksi)		% error
		k ₁	k ₂	k ₃		Predicted	Measured	
A-6 with 0% lime	1	1.08E+04	-0.0253	-1.8131	0.981	97	102	-4.90
	2	1.36E+06	-1.3734	-1.7999	0.985	98		-3.92
	3	4.29E+01	1.5076	-1.5884	0.915	80		-21.57
A-6 with 5% lime	1	5.21E+04	-0.1358	-0.4005	0.988	722.1	712.7	1.32
	2	2.34E+04	0.2320	-0.5956	0.996	719.9		1.01
	3	7.40E+01	1.7002	-0.3648	0.867	734.4		3.04
A-6 with 7% lime	1	6.75E+04	-0.2187	0.0556	0.993	1096.8	1081	1.46
	2	1.45E-03	4.7044	-0.8198	0.996	1084.3		0.31
	3	1.17E+03	1.1070	-0.3458	0.922	1074		-0.65
A-7-6 with 0% lime	1	7.34E+03	-0.0346	-1.2188	0.930	78	79	-1.27
	2	8.62E+06	-1.8442	-1.2405	0.913	78		-1.27
	3	8.19E+01	1.2014	-1.5119	0.845	78		-1.27
A-7-6 with 5% lime	1	6.91E+04	-0.0113	-0.5507	0.987	875.2	869.1	0.70
	2	6.90E+01	1.7708	-0.7117	0.988	877.3		0.94
	3	3.56E+01	1.9345	-0.7222	0.968	858.6		-1.21
A-7-6 with 7% lime	1	4.04E+04	0.0548	-0.4750	0.996	509.4	511	-0.31
	2	3.02E+09	-2.9001	-0.1213	0.997	509.3		-0.33
	3	1.34E+03	0.8520	-0.3556	0.995	499.1		-2.33

Note: M_R = Resilient Modulus, is calculated at 10 psi deviator stress and 0 psi confining pressure

Chapter 5 DURABILITY STUDY OF LIME-STABILIZED SOILS

5.1 GENERAL

Pavement subgrade level faces durability concerns during design life due to freeze-thaw (F-T) and seasonal saturation. An experimental study is carried out to understand the durability performance of clayey subgrade soils with and without lime treatment. Laboratory resilient modulus (M_R) and unconfined compressive strength (UCS) test results are presented and discussed in this chapter considering the most common durability issues of pavement structures.

Specific objectives of this chapter are:

- 1) Evaluate the deleterious effect of freeze-thaw cycles on untreated and lime-stabilized soils in terms of resilient properties and strength in the laboratory;
- 2) Determine resilient modulus values prior and post soaking in water for 48 hours for all soil combinations to observe durability under worst wetting conditions;
- 3) Assess the long term improvement on clayey subgrade soils due to lime treatment.

5.2 FREEZE-THAW DURABILITY

Chapter 4 has the database for resilient modulus of soils at different moisture states with no freeze-thaw damage which is termed as fresh samples for durability study. 4 inch diameter samples were compacted at optimum moisture content, cured, subjected to specific freeze-thaw cycles in the environmental chamber, tested for resilient modulus and failed by unconfined compression. The numbers of F-T cycles were 1, 10 and 20. One representative sample was prepared and tested for each combination of soils and F-T cycles due to time constraint. F-T

samples were tested after thawing period to simulate the worst condition of pavement structure. As subgrade soils are moisture sensitive (as discussed in chapter 4), soil samples were covered with plastic wrap to control the moisture flow during thawing (30 °C with 40% relative humidity) period. Each samples exhibited different compaction and post UCS moistures. However, molding moisture (optimum water content) in damaged sample is considered to compare results with fresh samples.

5.2.1 Resilient Modulus Test Results

Table 5.1 to 5.4 summarizes the resilient modulus values of untreated and lime-treated subgrade soils, respectively, with and without F-T damage. It is clear that M_R values decrease with F-T cycles in both untreated and lime-treated soils. Apparently, water repeatedly freezes and melts within soil's porosity during freezing and thawing cycles. Thawing initiate the accumulation of water within samples which freezes and forms the ice crystals. Thus soils expand and weaken the intergranular bond between soil particles. Khoury (2002) stated two situations that can cause deleterious effects of F-T cycles: a) insufficient voids to let water particle expand without causing major disturbance to structure and b) presence of sufficient water in soils. These two factors lead toward significant damage in soil samples that are subjected to F-T cycles. Similar to fresh sample, resilient modulus values also decrease with deviator stress for all soil combinations which indicates softening of soil samples at higher stress for damaged soils. For comparison purpose, resilient modulus values at 10 psi deviator stress and zero psi confining pressure are considered.

5.2.1.1 Untreated Raw Soils

Resilient modulus test was conducted according to AASHTO T 307 test sequences in confined and unconfined state after 1, 10 and 20 F-T cycles for untreated soils. M_R results (including fresh sample with no F-T) are presented in Table 5.1 and Table 5.2, respectively, for untreated A-6 and A-7-6 soils. Figure 5.1 and 5.2 graphically illustrate the resilient modulus value subjected to different F-T cycles for untreated A-6 and A-7-6, respectively, at specific 4 psi (27.8 kPa) confining pressure. For raw A-6 soils, M_R values subjected to 1, 10 and 20 cycles of F-T are approximately 75%, 85% and 87% lower than M_R values with no freeze-thaw. These values range between 20-36 ksi (138-248 MPa), 12-21 ksi (83-145 MPa) and 11-20 ksi (76-138 MPa) for 1, 10 and 20 F-T cycles, respectively, compare to 95-145 ksi (655-1000 MPa) for fresh samples. Raw A-7-6 soils are relatively less damaged due to F-T cycles. In comparison with no F-T damage, untreated A-7-6 soils with 1, 10 and 20 F-T cycles observe approximately 65%, 75% and 80% lower M_R values. Range of resilient modulus values for 0, 1, 10 and 20 cycles are 75-100 ksi (518-690 MPa), 18-40 ksi (124-276 MPa), 14-29 ksi (97-200 MPa) and 12-26 ksi (83-179 MPa), respectively, at different stress levels in test program. It is clear from Figure 5.1 and 5.2 that, the decrease in M_R in 0 to 1 F-T cycles is relatively higher than any other F-T cycles for both soils. Khalife et al. (2012) commented that freezing and thawing action open up the pores in soils during initial damage, thus reducing the damaging effects for later F-T cycles. It is to be mentioned that the M_R values of untreated A-6 and A-7-6 soils after F-T damage is more close to MEPDG recommended value of that particular. These ranges of raw soil's M_R are also common to obtain as back calculated modulus from field Falling Weight Deflectometer (FWD) test. Thus selected F-T cycles (according to ASTM C1645) is quite representative to field conditions.

5.2.1.2 Stabilized Soils

Resilient modulus test was performed according to unconfined high stress sequences for lime stabilized soils subjected to 10 and 20 F-T cycles. M_R results for lime stabilized A-6 and A-7-6 soils with or without F-T damage are presented in Table 5.3 and 5.4 and graphically illustrated in Figure 5.3 and 5.4 respectively. Analogous to untreated soils, samples are also damaged with F-T cycles for lime stabilized soils case. However, less damage percentages (with respect to fresh samples) are obtained for stabilized soils compared to untreated counterpart. For example, F-T damages are within 15% and 22% for A-6 soils with 5% and 7% lime dose, respectively, after 20 F-T cycles (Table 5.2). Similar qualitative trend is obtained for A-7-6 (Table 5.3) soils which exhibit approximately 20% and 35% damage after 20 F-T cycles for 5% and 7% lime treatment respectively. It is speculated that some pozzolanic reactions occur in lime stabilized soils due to moisture flow in thawing phase. These facts may contribute in minimizing the freeze-thaw damage in lime stabilized soils (Khoury 2002).

To the author's knowledge, only two studies (Khalife et al. 2012, Solanki et al. 2013) are found in open literature which evaluated the resilient modulus values of stabilized subgrade soils of Oklahoma after freeze-thaw cycles. They obtained high damage percentage (>80%) on lime stabilized subgrade soils due to F-T action. This was due to the fact that freeze-thaw temperature was quite high according to ASTM D560 which was withdrawn in 2012 due to variability associated within the test methods (Shihata and Baghdadi 2001). Moreover, availability of free water during thawing phase allowed capillary action in soils to simulate the presence of ground water table (GWT) in the field. This may be true for Oklahoma condition; no capillary action is expected for New Mexico subgrade soils as GWT location is too low to produce capillary action.

5.2.2 Unconfined Compressive Strength Test Results

After resilient modulus tests, unconfined compressive strength (UCS) test was conducted on same samples to obtain failure strength. Table 5.5 presents the UCS results for raw and lime stabilized soils subjected to 0, 1, 10 and 20 F-T cycles. All the tested samples generally show a reduction in UCS values with the increase of F-T cycles. Similar to M_R results, subgrade soils become more durable due to lime treatment after F-T action. For example, UCS value reduces to 82 psi (20 F-T cycles) from 133 psi (fresh samples) for untreated A-6 soils, thus exhibits 38% damage due to F-T action. In comparison, UCS of 5% lime stabilized A-6 soil decreases to 438 psi (20 F-T cycles) from 578 psi (fresh samples), which shows 10% damage due to F-T action.

5.2.3 Effects of Soils Type

The effect of F-T action on test result varies from one soil-lime mixture to another. Figure 5.5 depicts the resilient modulus value with F-T cycles for all soil-lime combinations. As mentioned before, both raw and stabilized soils exhibit reduction in M_R values with increasing F-T cycles. Raw soils with initial F-T damage (after 1 F-T cycle) indicate that highest F-T damage occurs within 0 to 1 F-T cycle. Test results also reveal that raw A-6 subgrade soils are more susceptible to F-T damage than raw A-7-6 soils. Fresh A-6 soils (102 ksi) show 40% high M_R than fresh A-7-6 soils (79 ksi). However, A-6 soils degrade more than A-7-6 soils and produces approximately similar M_R (11.7 ksi and 12.2 ksi for A-6 and A-7-6 soils respectively) at the end of 20 F-T cycles. This trend is clearly visualized in Figure 5.6 for maximum resilient modulus results at 6 psi confining pressure and 10 psi deviator stress combinations. Figure 5.6 displays the resilient modulus results at two different stress states for untreated A-6 and A-7-6 soils subjected to 1, 10 and 20 F-T cycles. This behavior can be explained from the percentage of clay

content in soils. From Table 3.1, % finer of 200 sieve (0.075 mm) is 49.6% and 74.2% for A-6 and A-7-6 soils respectively. With low clay content, A-6 soils have more voids with entrapped water which freezes and thaws and cause more damage than A-7-6 soils. Huang (2004) commented that less clayey soils (A-6 soils) become more frost susceptible due to relatively high permeability than A-7-6 soils.

5.2.4 Effects of Lime Treatment

Figure 5.7 and 5.8 illustrate the percentage of F-T damage in resilient modulus and UCS values for different soil-lime combinations. Damage percentages are calculated between 0-10, 0-20 and 10-20 F-T cycles. A sample calculation of % damage in 0-10 and 10-20 cycles are given below in Eq. 5.1 and 5.2 respectively:

$$\% F - T \text{ damage in } 0 \text{ to } 10 \text{ cycles} = \frac{\text{Fresh sample } M_R - 10 \text{ cycles } M_R}{\text{Fresh sample } M_R} \times 100 \quad (5.1)$$

$$\% F - T \text{ damage in } 10 \text{ to } 20 \text{ cycles} = \frac{10 \text{ cycles } M_R - 20 \text{ cycles } M_R}{10 \text{ cycles } M_R} \times 100 \quad (5.2)$$

It is clear from Figure 5.7 and 5.8 that F-T damage percentages decrease for all stabilized soils compare to raw subgrade soils. For example, with respect to resilient modulus value (Figure 5.7), 84.6% damage of untreated A-7-6 soils minimizes to 17% and 27.1% for same soils with 5% and 7% lime dose, respectively, after 20 cycles of F-T action. Similarly, 32.3% reduction in UCS value for untreated A-7-6 soils reduces to 9.9% and 15.1% for 5% and 7% lime stabilized A-7-6 soils respectively. Among three damage cycles, 0-10 F-T cycles shows maximum damage in all soil-lime combinations. In compare to 5% lime treatment, soils with 7% lime dose exhibit higher

damage percentage. This is because permeability increases with an increase in lime content (Solanki et al. 2009), that reduces the F-T durability of higher percentage lime stabilized soils. Similar with fresh samples, A-6 soils with 7% lime shows highest M_R values among all combinations after F-T actions (Figure 5.5).

5.3 SOAKING DURABILITY

Clayey subgrade soils have low resilient modulus in wet moisture state. Thus fully saturation state is another worst scenario pavement subgrade can observe in their service life. To observe the performance of untreated and lime-treated subgrade soil under fully submerged or soaked condition, a sample compacted at optimum moisture state was fully submerged in water and stored in the bucket for 48 hours prior to UCS testing. All buttons for deformation measurement and plastic wrap were removed to penetrate water through any surface of soil. It was observed that both untreated raw A-6 and A-7-6 sample collapsed and crumbled completely to mud formation. But all lime-stabilized samples remained intact. The surface of the samples were then dried by using towels and immediately covered again with plastic wrap. Weight of the sample was not comparable as some soil and glue were lost from the button space during soaking. Buttons were replaced again and capping was done prior resilient modulus testing. Figure 5.9 shows the photograph of untreated and lime-treated A-6 soil after 48 hours soaking.

The resilient modulus test was conducted on the same sample prior and post soaking in water. It is observed that resilient modulus values increase in most cases in lime-stabilized soils after 48 hours of soaking. Table 5.5 shows the resilient modulus results before and after soaking. Paired two sample tests of means are done on these results at 95% level ($\alpha = 0.05$). Results show that

there is no significant difference in modulus values due to soaking for all cases except A-6 soil with 7% lime. Increase in moisture content in soil samples is expected due to submergence. These enhance and accelerate the chemical reactions in lime stabilized soils, resulting in strength gain and modulus increment. Fully submerged condition works as an enhanced curing time for lime-stabilized soil. Thus lime stabilization is an excellent option for pavement with high ground water table.

5.4 SUMMARY

In this chapter, resilient modulus and unconfined compressive strength tests results are presented and discussed for untreated and lime treated A-6 and A-7-6 subgrade soils subjected to F-T and soaking durability. Summary findings are:

- Clayey subgrade soils become more durable to freeze-thaw action due to lime treatment. High percentage reduction (>80%) in resilient modulus values of untreated soils due to F-T cycles can be minimized within 35% reduction for lime stabilized soils case.
- Though fresh A-6 samples with no F-T damage, show 40% high M_R than A-7-6 soils, raw A-6 soils exhibit high damage and show less M_R due to F-T action compare to raw A-7-6 soils.
- 48 hours soaking does not show any detrimental effect in the resilient modulus of lime stabilized soils, but untreated soils collapse fully due to soaking.

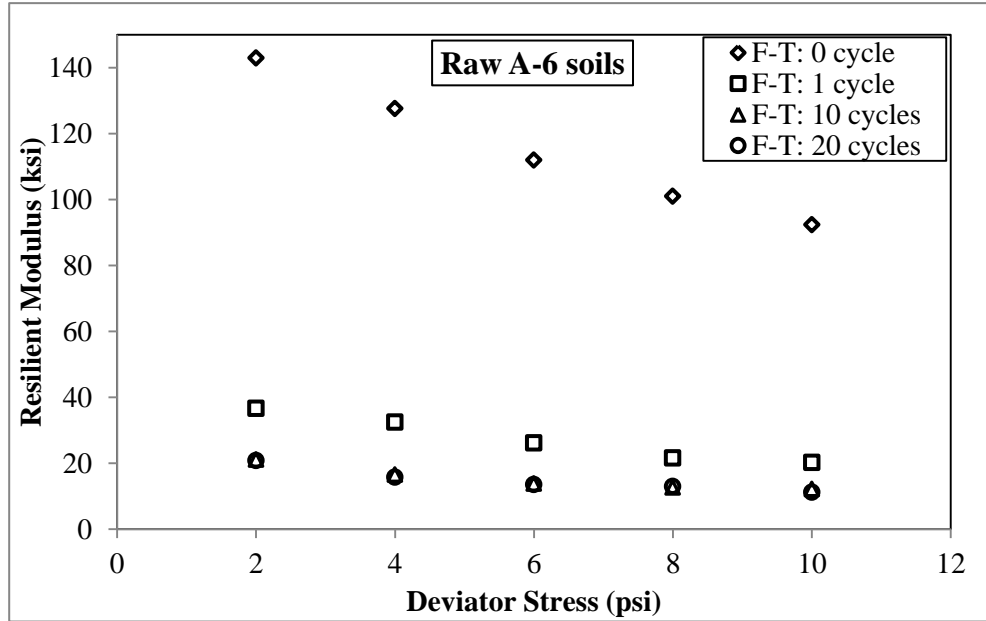

Figure 5.1 Resilient Modulus Plot for Raw A-6 Soils Subjected to Different F-T Cycles

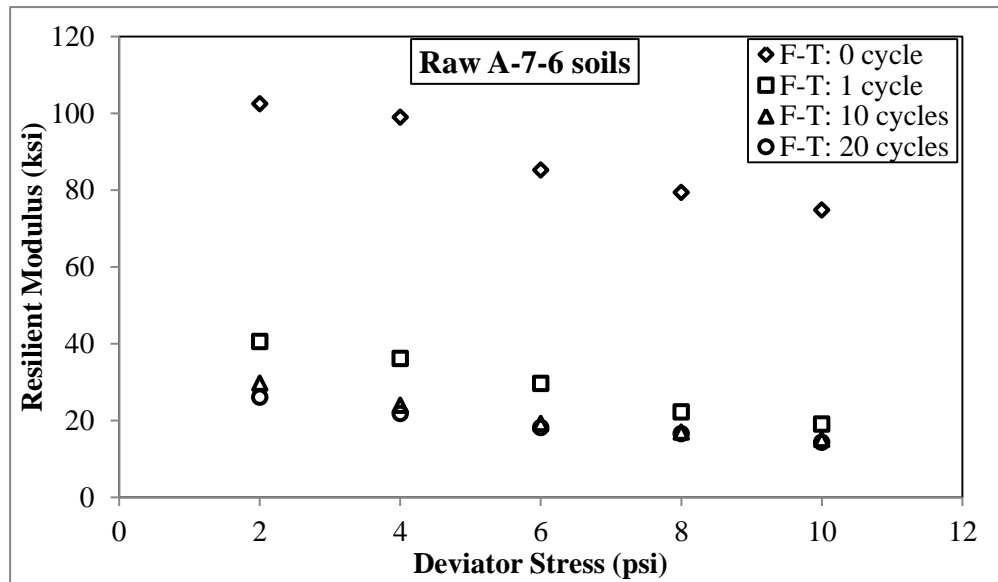
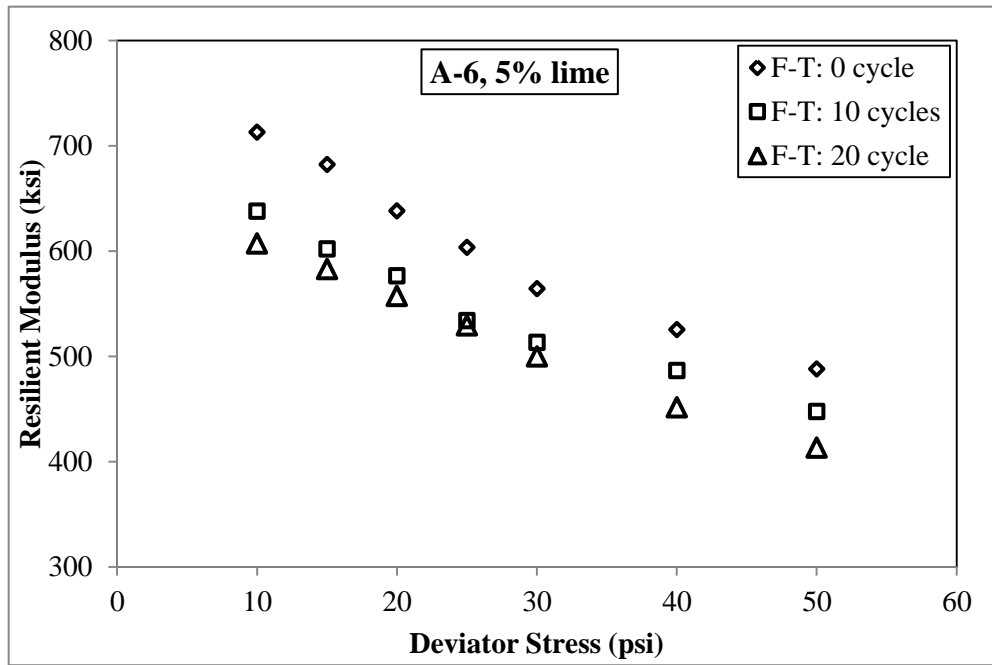
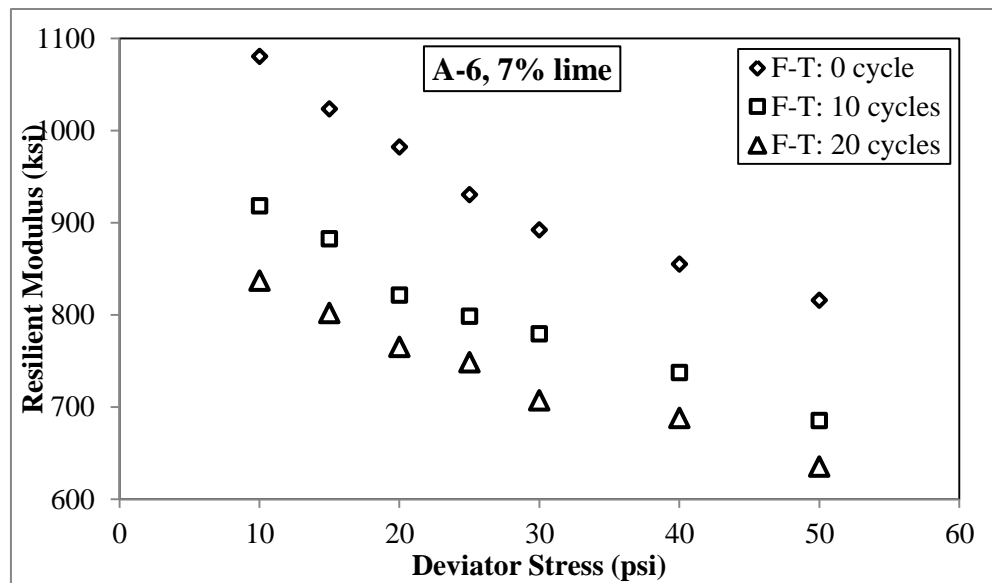

Figure 5.2 Resilient Modulus Plot for Raw A-7-6 Soils Subjected to Different F-T Cycles



(a) A-6 soils with 5% lime



(b) A-6 soils with 7% lime

Figure 5.3 Resilient Modulus Plot for Lime-treated A-6 Soils Subjected to Different F-T Cycles

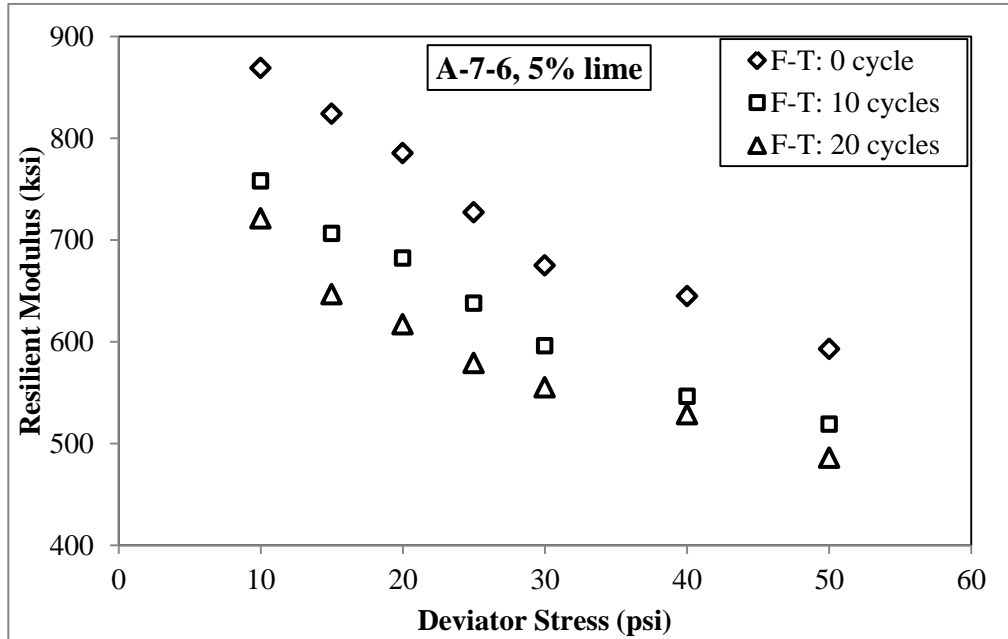

(a) A-7-6 soils with 5% lime

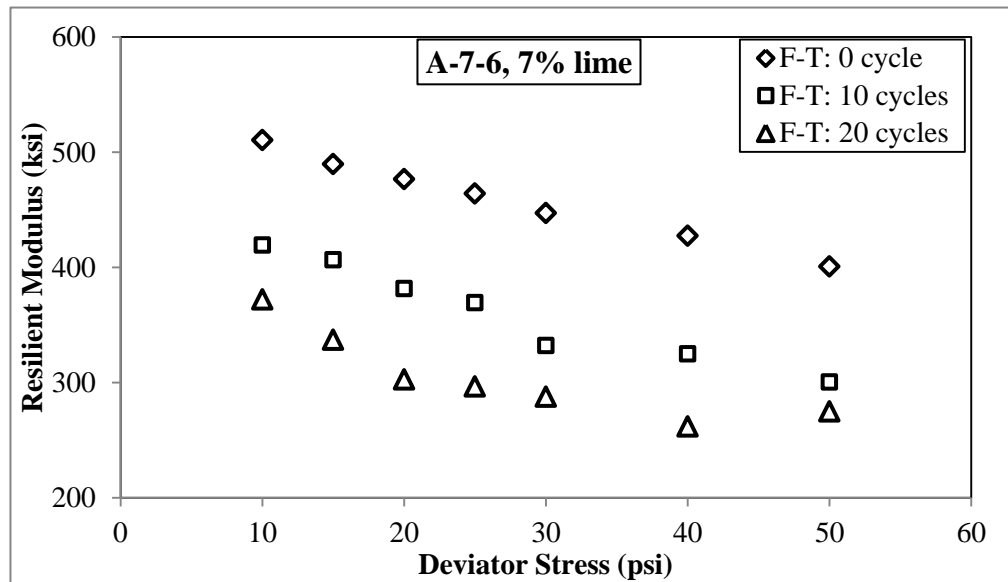

(b) A-7-6 soils with 7% lime

Figure 5.4 Resilient Modulus Plot for Lime-treated A-7-6 Soils Subjected to Different F-T Cycles

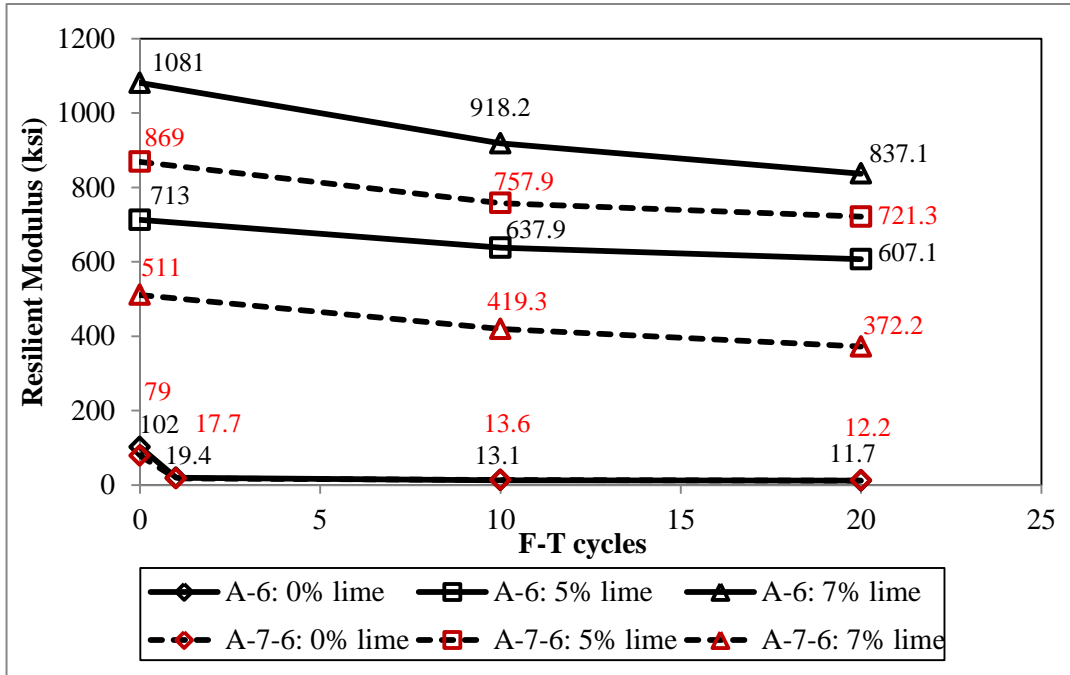

Figure 5.5 Resilient Modulus Plot with F-T Cycles for Different Soil-Lime Combinations (SD=10 psi, CP=0 psi)

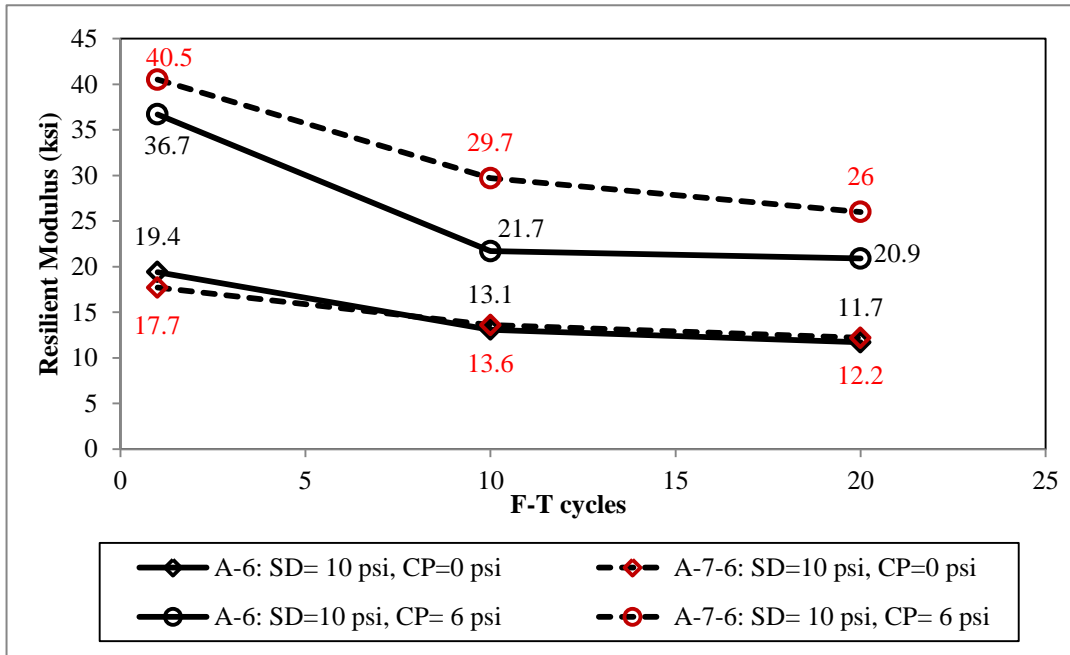

Figure 5.6 Resilient Modulus Plot with F-T Cycles for Untreated Soils at Different Stress Levels

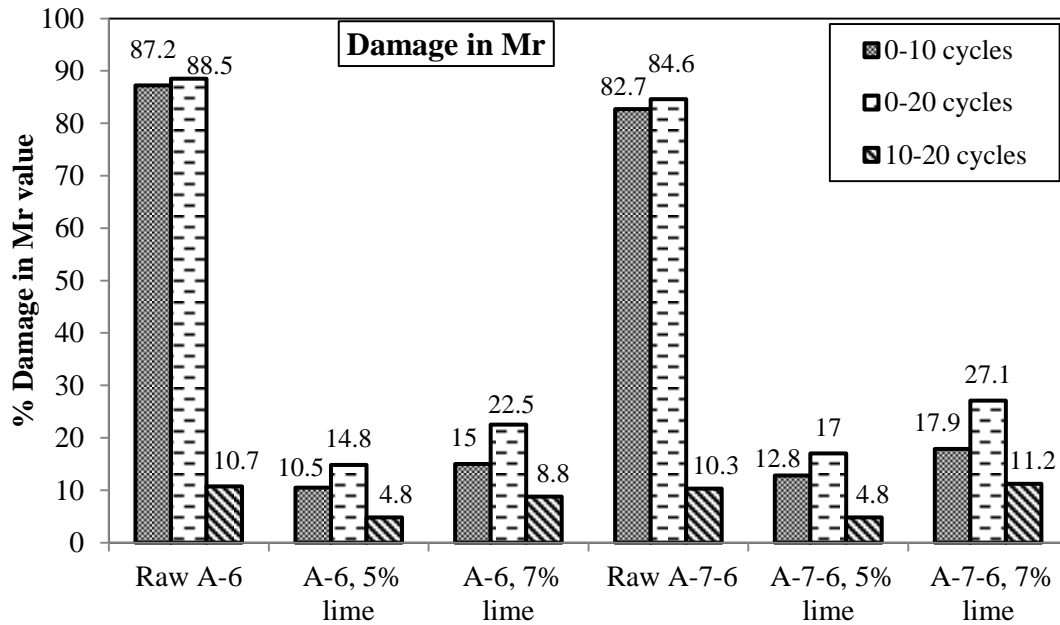

Figure 5.7 Percentage Damage in Resilient Modulus Values for Different Soil-Lime Combinations

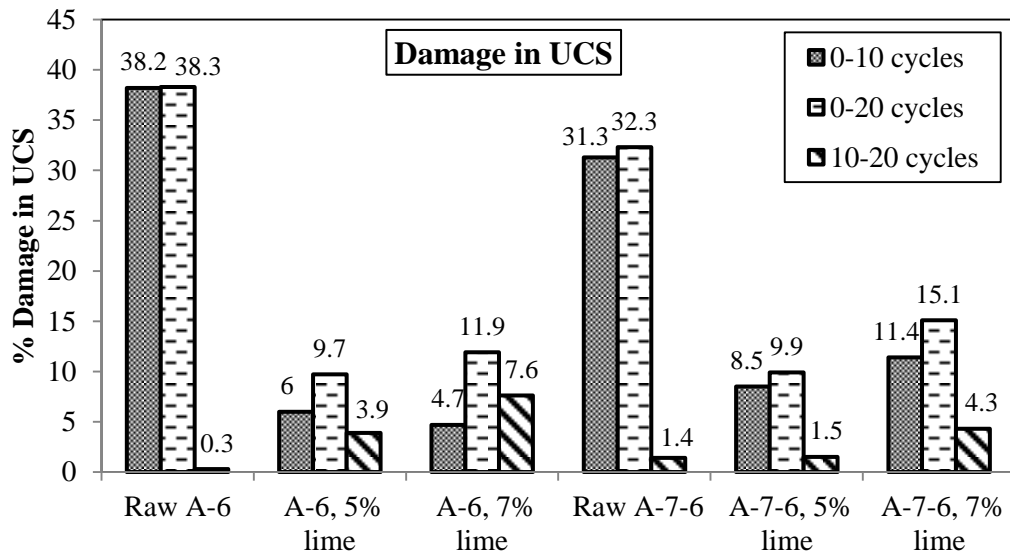

Figure 5.8 Percentage Damage in UCS Values for Different Soil-Lime Combinations



a) Untreated A-6 soils



b) Lime treated A-6 soil

Figure 5.9 Soaked Subgrade Soil Samples

Table 5.1 Resilient Modulus Results for Untreated A-6 Subjected to F-T cycles

Cell Pressure (psi)	Deviator stress (psi)	No F-T	1 F-T		10 F-T		20 F-T	
		w=15.5%	w=15.8%	%	w=16.1%	%	w=15.5%	%
		Mr (ksi)	Mr (ksi)	Damage	Mr (ksi)	Damage	Mr (ksi)	Damage
6	2	143	36.7	74.3	21.1	85.2	20.9	85.4
6	4	128	32.5	74.5	16.6	87.0	15.8	87.6
6	6	112	26.2	76.6	13.9	87.6	13.5	87.9
6	8	101	21.6	78.6	12.7	87.4	12.9	87.2
6	10	92	20.2	78.1	12.2	86.8	11.3	87.8
4	2	145	37.6	74.1	19.6	86.5	19.8	86.4
4	4	129	31.6	75.4	15.6	87.9	16.1	87.5
4	6	115	24.1	79.1	13.5	88.3	13.4	88.4
4	8	105	21.3	79.6	12.4	88.1	12.3	88.2
4	10	95	20.0	78.9	12.2	87.1	11.4	88.0
2	2	141	37.3	73.5	20.0	85.8	19.4	86.2
2	4	132	30.9	76.5	15.6	88.1	15.7	88.1
2	6	116	23.5	79.7	13.3	88.5	13.8	88.1
2	8	104	20.9	79.8	12.4	88.0	12.1	88.3
2	10	94	19.7	79.0	12.2	86.9	10.9	88.4
0	2	144	37.0	74.3	19.2	86.7	15.6	89.1
0	4	133	30.6	76.9	15.8	88.1	13.2	90.1
0	6	120	23.4	80.6	14.1	88.3	12.7	89.4
0	8	108	20.6	80.9	13.4	87.7	11.6	89.3
0	10	102	19.4	81.0	13.1	87.2	11.7	88.5

Table 5.2 Resilient Modulus Results for Untreated A-7-6 Subjected to F-T cycles

Cell Pressure (psi)	Deviator stress (psi)	No F-T	1 F-T		10 F-T		20 F-T	
		w=15.1%	w=15.3%	% Damage	w=15.5%	% Damage	w=15.1%	% Damage
		Mr (ksi)	Mr (ksi)		Mr (ksi)		Mr (ksi)	
6	2	103	40.5	60.5	29.7	71.0	26	74.6
6	4	99	36.1	63.5	23.9	75.9	21.8	78.0
6	6	85	29.6	65.3	19.2	77.5	18.1	78.8
6	8	79	22.2	72.0	16.9	78.7	16.5	79.2
6	10	75	19.0	74.5	15.0	79.9	14.3	80.9
4	2	99	39.1	60.3	28.2	71.4	24.5	75.1
4	4	92	34.8	62.2	21.9	76.2	20.2	78.0
4	6	82	27.2	66.8	18.2	77.7	17.2	78.9
4	8	79	21.7	72.5	16.2	79.4	14.3	81.8
4	10	76	18.5	75.7	15.2	80.1	12.5	83.5
2	2	97	38.3	60.6	28.4	70.8	23.4	75.9
2	4	96	33.4	65.0	22.0	77.0	20.5	78.5
2	6	85	26.2	69.1	18.3	78.5	17.7	79.2
2	8	82	20.9	74.5	16.2	80.2	14.9	81.8
2	10	78	18.2	76.5	15.1	80.6	13.1	83.2
0	2	106	39.0	63.2	25.9	75.5	23.9	77.5
0	4	101	34.2	66.1	21.0	79.2	20.7	79.5
0	6	91	26.5	70.7	17.4	80.8	18	80.1
0	8	85	20.7	75.5	15.6	81.6	14.6	82.7
0	10	79	17.7	77.7	13.6	82.7	12.2	84.6

Table 5.3 Resilient Modulus Results for Lime-treated A-6 Subjected to F-T cycles

Deviator Stress (psi)	A-6 soils, 5% lime					A-6 soils, 7% lime				
	No F-T	10 F-T		20 F-T		No F-T	10 F-T		20 F-T	
	w=17.6%	w=17.9%	%	w=18.1%	%	w=18.5%	w=19.1%	%	w=18.9%	%
	Mr (ksi)	Mr (ksi)	Damage	Mr (ksi)	Damage	Mr (ksi)	Mr (ksi)	Damage	Mr (ksi)	Damage
10	713	637.9	10.5	607.1	14.8	1081	918.2	15.0	837.1	22.5
15	682	601.9	11.8	582.7	14.6	1024	882.6	13.8	801.9	21.7
20	638	576.4	9.7	557.3	12.7	982	821.3	16.4	765	22.1
25	603	533.7	11.5	529.2	12.3	930	798.5	14.2	748.2	19.6
30	564	513.3	9.0	499.8	11.4	892	779.2	12.7	707	20.8
40	525	486.5	7.4	451.6	14.0	855	737.2	13.8	688	19.5
50	488	447.4	8.3	413.1	15.3	816	685.3	16.0	635.2	22.1

Table 5.4 Resilient Modulus Results for Lime-treated A-7-6 Subjected to F-T cycles

Deviator Stress (psi)	A-7-6 soils, 5% lime					A-7-6 soils, 7% lime				
	No F-T	10 F-T		20 F-T		No F-T	10 F-T		20 F-T	
	w=16.4%	w=16.1%	%	w=16.5%	%	w=17.7%	w=17.6%	%	w=18.0%	%
	Mr (ksi)	Mr (ksi)	Damage	Mr (ksi)	Damage	Mr (ksi)	Mr (ksi)	Damage	Mr (ksi)	Damage
10	869	757.9	12.8	721.3	17.0	511	419.3	17.9	372.2	27.1
15	824	706.5	14.3	646.6	21.5	490	406.4	17.0	337.1	31.1
20	785	682.2	13.1	617.1	21.4	477	381.4	20.0	302.5	36.5
25	727	637.9	12.3	579	20.4	464	369.2	20.4	296.6	36.1
30	675	596.1	11.7	555.3	17.7	447	332.1	25.7	287.6	35.7
40	645	546.4	15.2	528.8	18.0	427	324.8	24.0	261.8	38.8
50	593	519.1	12.5	486	18.0	401	300.3	25.1	274.8	31.4

Table 5.5 UCS Results for All Soils Subjected to F-T Cycles

Type of soils	% of lime additive	Number of F-T cycle			
		0	1	10	20
		UCS (psi)			
A-6	0	133	92.1	82.2	82
	5	578	NT	466	438.2
	7	601	NT	572.9	529.2
A-7-6	0	113	86.2	77.6	76.5
	5	434	NT	397	391
	7	364	NT	323	309.2

Note: NT = No Test was conducted for this F-T cycle, UCS= Unconfined Compressive Strength

Table 5.6 Effect of Soaking on Resilient Modulus Value using Statistical Analysis

Deviator stress (psi)	A-7-6, 5% Lime		A-7-6, 7% Lime		A-6, 5% Lime		A-6, 7% Lime	
	Mr (ksi)	Mr after soaking (ksi)	Mr (ksi)	Mr after soaking (ksi)	Mr (ksi)	Mr after soaking (ksi)	Mr (ksi)	Mr after soaking (ksi)
10	858	876	500	521	721	734	1116	1157
15	811	817	494	493	692	673	1066	1090
20	798	796	482	484	645	644	1025	1050
25	701	722	468	480	616	618	980	1017
30	643	647	441	446	587	573	927	1004
40	629	622	421	418	538	543	883	972
50	582	579	387	398	494	490	840	929
p value	0.2416		0.0729		0.5430		0.0027	
Statistical Significance	No		No		No		Yes	

Chapter 6 SUMMARY, CONCLUSIONS AND RECOMMENDATIONS

6.1 SUMMARY

This study examines the effect of lime as chemical stabilizer for clayey subgrade soils of New Mexico. In particular, improvement of engineering properties and long term durability performance are evaluated due to lime treatment. Changes of laboratory resilient modulus (M_R) and unconfined compressive strength (UCS) values are considered as an indicator to observe these performances. Moreover, effects of moisture and suction on resilient modulus values of lime stabilized soil are also studied. An attempt is made to incorporate suction parameters in traditional stress dependent resilient modulus models.

In this study, two clayey subgrade soils: AASHTO A-6 and A-7-6 were collected from roadway project of New Mexico. Two lime percentages (5% and 7%) were selected based on pH test. Moisture density relationship was developed for all soil-lime combinations. Cylindrical soil samples were compacted at untreated (no lime) and lime treated (5% and 7%) conditions conferring to NCHRP 1-28A using impact compaction effort. Samples were completely covered with plastic wrap to mitigate moisture loss. Lime stabilized soils were then cured for 7 days at 40 °C. Resilient modulus test for untreated soils was conducted according to AASHTO T 307 test sequences for subgrade soils. However, M_R tests on lime treated soils were conducted with a modified stress sequence incorporated in the AASHTO T 307 procedure based on past literature and laboratory experience gained in this study. UCS test was conducted using a strain controlled test program within the universal test system. Repeatability and reproducibility of test results were assured by using 4 inch diameter samples.

For first study, samples were reconstituted at dry, optimum and wet conditions to assess the engineering properties (M_R and UCS) with molding moisture for untreated and lime-treated soils. Soil suction tests were conducted at similar moisture levels using filter paper method. Total and matric suction components were determined indirectly by measuring filter paper water content after equilibrium. Hence, the relationship between resilient modulus with different suction components was developed. Then suction was incorporated in the stress-dependent resilient modulus models.

For durability study, untreated and lime treated soils were subjected to different freeze-thaw (F-T) cycles and 48 hours soaking in water. One sample at optimum moisture state was prepared, cured and subjected to F-T cycles. Each F-T cycle consisted of -5 °C of freezing for 16 hours and 30 °C of thawing for 8 hours. M_R and UCS tests were conducted after desired F-T cycles (1, 10, 20 for untreated soils and 10, 20 for lime treated soils). Similarly, soaking durability was observed by conducting M_R tests on soil-lime samples after 48 hours of submergence in water.

6.2 CONCLUSIONS

From the analyses and discussions of laboratory test results presented in preceding chapters, the following conclusions can be drawn:

1. Lime is an effective stabilizing agent to improve the resilient properties (M_R) and strength (UCS) of clayey subgrade soils. Increment of these engineering properties depends on soil type and lime dose. A-6 soil exhibits high M_R with high dose of lime. A-7-6 soils shows reduction in M_R at 7% dose than M_R value at 5% lime. 5% lime addition increases M_R values approximately 6

and 10 times in A-6 and A-7-6 soils, respectively, from their untreated soils counterpart. However, 7% lime dose decreases M_R value to 41% from 5% lime dose in A-7-6 soil. Similar trend is observed in UCS values. Considering this results, 5% lime is the design optimum lime content of A-7-6 soil, whereas for A-6 soil it may be 7% or more, which is not being able to determine exactly from this study.

2. Moisture is a sensitive parameter for both untreated and lime treated subgrade soils. M_R and UCS values decrease with the increase of moisture during compaction. Influence of moisture in these parameters can be minimized due to lime treatment in raw subgrade soils.

3. Though less time and material required, 2.8 inch diameter sample is a concern for their lack to repeatability and higher coefficient of variance among replicate samples. This conclusion is verified by both resilient modulus and unconfined compressive strength test results. Thus 4 inch sample should be compacted and tested for subgrade soils.

4. Addition of lime increases all suction (total, matric and osmotic) values of untreated subgrade soils. Osmotic suction increases about 15% of total suction due to lime treatment for both A-6 and A-7-6 soils. Higher suction enhances the rigidity of the structure, thus resilient modulus value increases with soil suction. Among suction components, osmotic suction correlates better with resilient modulus in compare to total and matric suction. Therefore, osmotic suction cannot be neglected for lime stabilized soils case.

5. Raw soils are very weak to resist freeze-thaw damage and collapse due to full saturation. Both A-6 and A-7-6 soils become damaged significantly due to 10 cycles of F-T, but damage percentage is high (85%) for A-6 soils than A-7-6 soils (75%). Though fresh raw A-6 soils, with no F-T damage, have 40% high M_R than A-7-6 soils; A-7-6 soils show high M_R than A-6 soils after 10 cycles of F-T. Presence of high clay content in A-7-6 soils makes it more F-T durable compare to A-6 soils.

6. Lime treatment can improve the long term performance of clayey subgrade soils. M_R values decrease only 22% and 35% for 7% lime stabilized A-6 and A-7-6 soils after 20 cycles of F-T. Possible occurrence of pozzolanic reaction in thawing phase minimizes the detrimental effect of freeze thaw cycles and makes the lime stabilized soils more durable.

7. Lime stabilization is an excellent option for pavement with high ground water table. Full submergence cannot affect the integrity of lime stabilized soils. No significant difference in resilient modulus is observed before and after soaking.

8. With limited data, soil suction is incorporated in traditional stress dependent resilient modulus models. Multiple regression analysis is performed to determine the constants of MEPDG M_R constitutive models for three different states: only stress state, stress-suction states, stress-suction-moisture states. Good correlation exhibits for all soil combination using Model 1 and 2. Moreover, incorporation of suction (Model 2) shows some improvement over predictions in Model 1. Thus suction can be considered in stress-dependent M_R models to demonstrate the moisture variation in clayey subgrade soils.

6.3 RECOMMENDATIONS

The following recommendations are made for future studies:

1. No standardized test method is established and recommended in the M_R test protocols for stabilized subgrade and unbound materials. Moreover, most of the available literatures have been conducted M_R test with simple but highly inaccurate external deformation techniques. Strain patches can be used at different locations in stabilized soils to accurately predict the deformations due to loading. An extensive resilient modulus test program should conduct for different stabilizing agents among different pavement agencies to establish test protocols for stabilized pavement materials.

2. Controlling suction during M_R test is a demanding topic to simulate field condition and obtain true field modulus. It is recommended to conduct research to develop suction controlled M_R test for untreated and chemically treated subgrade soils.

3. Stabilization of natural soils with chemical stabilizer makes them stronger material, even more than base/subbase layers. Thus pavement system is required to design as inverted when chemical stabilizer is used in subgrade soils. Pavement design method do not account this effect, which should get attention to make economic and durable pavement structure.

4. Permeability of soils is very important to understand the effect of freeze-thaw action. It is recommended to conduct pneumatic tests to obtain soil-gas permeability in unsaturated soils for better understanding of freeze-thaw damage.

5. Durability of unbound and subgrade layers is a concern in design phase to assess long term pavement performance. But no standard test protocols are available to conduct durability tests for these pavement layers. It is important to conduct research in developing F-T and other durability test standards.

6. Sensitivity analysis should be done in regression constants of M_R predictive models to observe the influence of different parameters in resilient modulus values. Moreover, future research is demanding to incorporate F-T damage in M_R models.

REFERENCES

- American Association of State Highway and Transportation Officials (AASHTO), (1986). "AASHTO guide for design of pavement." Washington D.C.
- AASHTO T 307 (1999). "Determining the Resilient Modulus of Soils and Aggregate Materials." *Standard Specifications for Transportation Materials and Methods of Sampling and Testing: Part 2B Tests*, Washington, D.C. pp. 733-758.
- AASHTO T 208 (2005). "Standard Method of Test for Unconfined Compressive Strength of Cohesive Soil." *Standard Specifications for Transportation Materials and Methods of Sampling and Testing*, AASHTO, Washington, D.C.
- AASHTO T 208 (2005). "Standard Method of Test for Unconfined Compressive Strength of Cohesive Soil." *Standard Specifications for Transportation Materials and Methods of Sampling and Testing*, AASHTO, Washington, D.C.
- AASHTO T 180 (2010). "Standard Method of Test for Moisture-Density Relations of Soils Using a 4.54-kg (10-lb) Rammer and a 457-mm (18-in.) Drop." *Standard Specifications for Transportation Materials and Methods of Sampling and Testing*, AASHTO, Washington, D.C.
- Andrei, D. (1999). "Development of a Harmonized Test Protocol for the Resilient Modulus of Unbound Materials Used in Pavement Design." M.S. thesis, University of Maryland.
- Andrei, D. (2003). "Development of a Predictive Model for the Resilient Modulus of Unbound Materials." PhD. Dissertation. Arizona State University.
- ASTM standard D5298 (2003). "Standard Test Method for Measurement of Soil Potential (suction) Using Filter Paper Method." *ASTM International*, West Conshohocken, PA, DOI: 10.1520/D5298-03, www.astm.org.

ASTM standard D560 (2003). “Standard Test Methods for Freezing and Thawing of Compacted Soil-Cement Mixtures, (Withdrawn in 2012).” *ASTM International*, West Conshohocken, PA, www.astm.org.

ASTM standard D6276-99a (2006)e1. Standard Test Method for using pH to Estimate the Soil-Lime Proportion Requirement for Soil Stabilization. *ASTM International*, West Conshohocken, PA, DOI: 10.1520/D6276-99AR06E01, www.astm.org.

ASTM D3551 (2008). “Standard Practice for Laboratory Preparation of Soil-Lime Mixtures Using Mechanical Mixer.” *ASTM International*, West Conshohocken, PA, DOI: 10.1520/D3551-08, www.astm.org.

ASTM D5102 (2009). “Standard Test Method for Unconfined Compressive Strength of Compacted Soil-Lime Mixtures.” *ASTM International*, West Conshohocken, PA, DOI: 10.1520/D5102-09, www.astm.org.

ASTM standard C1645 (2011). “Standard Test Method for Freeze-Thaw and De-Icing Salt Durability of Solid Concrete Interlocking Paving Units.” *ASTM International*, West Conshohocken, PA, DOI: 10.1520/C1645_C1645M-11, www.astm.org.

Barksdale, R. D., Alba, J., Khosla, N. P., Kim, Y. R., Lambe, P. C. and Rahman, M. S. (1997). “Laboratory Determination of Resilient Modulus for Flexible Pavement Design.” NCHRP Web Document 14 for Project 1-28. Transportation Research Board, National Research Council, Washington, D.C.

Bejarano, M. O., Heath, A. C. and Harvey, J. T. (2003). “A Low-Cost High-Performance Alternative for Controlling a Servo-Hydraulic System for Triaxial Resilient Modulus Apparatus.” Resilient Modulus Testing for Pavement Components. *ASTM STP 1437*, West Conshohocken, PA.

- Bishop, A. W. (1959). "The Principle of Effective Stress." *Teknisk. Ukeblad*, Vol. 106, No. 39, pp. 859–863.
- Boudreau, R., and Wang, J. (2003). "Resilient Modulus Test – Triaxial Cell Interaction." Resilient Modulus Testing for Pavement Components. *ASTM STP 1437*, West Conshohocken, PA.
- Boynton, R.S. (1972). "Chemistry and Technology of Lime and Limestone," John Wiley and Sons, New York.
- Bulut, R., Lytton, R. L. and Wray, W. K. (2001). "Soil Suction Measurements by Filter Paper. Expansive Clay Soils and Vegetative Influence on Shallow Foundations," *Geotechnical Special Publication 115*, ASCE, pp. 243–279.
- Burczyk, J. M., Ksaibati, K., Anderson-Sprecher, R. and Farrar, M. J. (1994). "Factors Influencing Determination of a Subgrade Resilient Modulus Value." In *Transportation Research Record: Journal of Transportation Research Board, No. 1462*, National Research Council, Washington, D.C., pp.72–78.
- Butalia, T. S., J. Huang, D. G. Kim, and F. Croft (2003). "Effect of Moisture Content and Pore Water Pressure Build on Resilient Modulus of Cohesive Soils." Resilient Modulus Testing for Pavement Components. *ASTM STP 1437*, West Conshohocken, PA.
- Cabrera, A.S. (2012). "Evaluation of the Laboratory Resilient Modulus Test using a Fine Grained New Mexico Subgrade Soil." M.S. Thesis, University of New Mexico.
- Ceratti, G. A., Gehling, W. Y. Y. and Nunez, W. P. (2004). "Seasonal Variations of Subgrade Soil Resilient Modulus in Southern Brazil." In *Transportation Research Record: Journal of Transportation Research Board, No. 1874*, National Research Council, Washington, D.C.

- Chang, D. T. (1995). "Resilient Properties and Microstructure of Modified Fly Ash-Stabilized Fine Grained Soils." In *Transportation Research Record: Journal of Transportation Research Board*, No. 1486, National Research Council, Washington, D.C., pp. 88–96.
- Chen, Y., Dai, W. and Wang, L. (2010). "Test Study on Road Performance of Soils Stabilized by Liquid Stabilizer in Seasonally Frozen Regions." Proc. Of 10th International Conference of Chinese Transportation Professional, pp. 3245-3252.
- Dempsey, B.J. and Thompson, M.R. (1968). "Durability Properties of Lime-Soil Mixtures." Highway Research Record, Vol. 235, pp. 61-75.
- Dempsey, B.J., Herlache, W.A. and Patel, A.J. (1986). "Climatic-Materials-Structural Pavement analysis Program." Transportation Research Record, No. 1095, Transportation Research Board, Washington, D.C., pp. 111-123.
- Drumm, E. C., Y. Boateng-Poku, and Pierce, T. J. (1990). "Estimation of Subgrade Resilient Modulus from Standard Tests." *Journal of Geotechnical Engineering*, ASCE, Vol. 116, No. 5, pp. 774-789.
- Drumm E. C., J. S. Reeves, M. R. Madgett and W. D. Trolinger. (1997). "Subgrade Resilient Modulus Correction for Saturation Effects." *Journal of Geotechnical and Geoenvironmental Engineering*, ASCE, Vol. 123, No. 7, pp. 663–670.
- Eades, J.L and Grim, R.E. (1960). "Reactions of Hydrated Lime with Pure Clay Minerals in Soil Stabilization," Highway Research Bulletin, Vol. 262, pp. 51-63.
- Fredlund, D.G., Bergan, A. T. and Wong, P. K. (1977). "Relation between Resilient Modulus and Stress Research Conditions for Cohesive Subgrade Soils." In *Transportation Research Record: Journal of Transportation Research Board*, No. 642, National Research Council, Washington, D.C., pp. 73–81.

- Fredlund, D. G. and H. Rahardjo (1993). "Soil Mechanics for Unsaturated Soils," John Wiley and Sons, New York.
- Geiman, Christopher M. (2005). "Stabilization of Soft Clay Subgrades in Virginia Phase I Laboratory Study." M.S. Thesis, Virginia Polytechnic Institute.
- George, K.P. and Uddin, W. (2000). "Subgrade Characterization Study for Highway Pavement Design," Final Report, MS Department of Transportation, FHWA/MS-DOT-RD-00-131.
- Groeger, J. L., Rada, G. R. and Lopez, A. (2003). "AASHTO T 307-Background and Discussion." Resilient Modulus Testing for Pavement Components, *ASTM STP 1437*, West Conshohocken, PA.
- Guettala, A., Houari, H., Mezghiche, B. and Chebili, R. (2002). "Durability of Lime-Stabilized Earth Blocks," *Courrier du Savoir*, Vol. 2, pp. 61-66.
- Herrier, G., Chevalier, C. Froumentin, M., Cuisinier, O., Bonelli, S. and Fry, J.J. (2012). "Lime Treated Soil as an Erosion-Resistant Material for Hydraulic Earthen Structures." Proceedings for 6th International Conference on Scour and Erosion, Paris, France, Paper ID. ICSE6-176, pp. 585-592.
- Heydinger, A. G. (2003). "Evaluation of Seasonal Effects on Subgrade Soils." In *Transportation Research Record: Journal of Transportation Research Board*, No. 1821, National Research Council, Washington, D.C., pp. 47-55.
- Huang, J. (2001). "Degradation of Resilient Modulus of Saturated Clay Due to Pore Water Pressure Buildup under Cyclic Loading." M.S. Thesis, Ohio State University.
- Huang, Y.H. (2004). "Pavement Analysis and Design." 2nd Edition, Pearson Prentice Hall, NJ.

- Jones, D.E. and Holtz, W.G. (1973). "Expansive Soils-the Hidden Disaster." *Journal of Civil Engineering*, Vol. 43, No. 8, pp. 49-51.
- Kim, D. and N. Siddiki. (2006). "Simplification of Resilient Modulus Testing for Subgrades." Publication FHWA/IN/JTRP-2005/23, Joint Transportation Research Program, Indiana Department of Transportation and Purdue University.
- Khalife, R., Solanki, P. and Zaman, M.M. (2012). "Evaluation of Durability of Stabilized Clay Specimens using Different Laboratory Procedures." *ASTM Journal of Testing and Evaluation*, Vol. 40, No. 3, pp. 363-375.
- Khoury, N.N. (2002). "The Effect of Freeze-Thaw and Wet-Dry Cycles on Resilient Modulus of Class C Fly Ash Stabilized Aggregate Base." MS Thesis, University of Oklahoma.
- Khoury, N. N., Zaman, M. M., Nevels, J. B. and Mann, J. (2003). "Effect of Soil Suction on Resilient Modulus of Subgrade Soil Using Filter Paper Technique." Presented at *82nd Annual Meeting of the Transportation Research Board*, Washington, D.C.
- Khoury, N, R. Brooks, C. Khoury and D. Yada. (2012). "Modeling Hysteric Behavior with Moisture Variation." *International Journal of Geomechanics*, Vol. 12, No. 5, pp. 519-527.
- Kim, Dong-Soo, and S. Drabkin (1994). "Accuracy Improvement of External Resilient Modulus Measurements Using Specimen Grouting to End Platens." In *Transportation Research Record: Journal of Transportation Research Board*, No. 1462, National Research Council, Washington, D.C., pp. 65-71.
- Konrad, J., and Robert, C. (2003). "Resilient Modulus Testing Using Conventional Geotechnical Triaxial Equipment." Resilient Modulus Testing for Pavement Components, Resilient Modulus Testing for Pavement Components, *ASTM STP 1437*, West Conshohocken, PA.

- Lee, W., Bohra, N. C., Altschaeffl, A.G. and White, T. D. (1997). "Resilient Modulus of Cohesive Soils." *Journal Geotechnical and Geoenvironmental Engineering*, ASCE, Vol. 123, No. 2, pp. 131-135.
- Liang, R. Y., S. Rabab'ah, and M. Khasawneh (2008). "Predicting Moisture-Dependent Resilient Modulus of Cohesive Soils using Soil Suction Concept." *Journal of Transportation Engineering*, Vol. 134, No. 1, pp. 34-40.
- Little, D.N., Scullion, T., Kota, P. and Bhuiyan, J. (1994). "Identification of the Structural Benefits of Base and Subgrade Stabilization." Report 1287-2, Texas Transportation Institute.
- Little, D.N. (1995). "Stabilization of Pavement Subgrades and Base Courses with Lime." Kendall/Hunt Publishing Company, Dubuque, IA.
- Little, D.N. (1996). "Evaluation of Resilient and Strength Properties of Lime-Stabilized Soils from the Denver, Co Area." Report for Chemical Lime Company.
- Little, D.N. (1999). "Evaluation of Structural Properties of Lime Stabilized Soils and Aggregates: Vol. 1 Summary of Findings." *National Lime Association Report*, Arlington, VA
- Little, D. N. (2000). "Evaluation of Structural Properties of Lime Stabilized Soils and Aggregates: Mixture Design and Testing Protocol for Lime Stabilized Soils." *National Lime Association Report*, Arlington, VA., Volume 3.
- Little, D.N. (2012). "Lime stabilization of subgrade soils for structural purposes: past evidence and future needs." *Lime: Building on the 100-year legacy of ASTM committee C07*, STP 1557, ASTM International, West Conshohocken, PA, pp. 35-59.
- Maxwell, A.A. and Joseph, A.H. (1967). "Vibration Study of Stabilized Layers of Pavement in Runway at Randolph Air Force Base," Proceedings for Second International Conference on the Structural Design of Asphalt Pavements, Univ. of Michigan, Ann Arbor.

- May, R. W., and Witczak, M. W. (1981). "Effective Granular Modulus to Model Pavement Responses," In *Transportation Research Record: Journal of Transportation Research Board*, No. 810, Transportation Research Board, pp. 1-9.
- McCallister, L.D. and Petry, T.M. (1990). "Property Changes in Lime-Treated Expansive Clays under Continuous Leaching." Technical Report GL-90-17, US Army Corps of Engineers, Vicksburg, MS.
- Miller, A. G., Zaman, M.M., Rahman, J. and Tan, K.N. (1999). "Laboratory and Field Evaluation of Soil Stabilization using Cement Kiln Dust." Draft Paper, Item 2144, ORA 125-5693, Submitted to Oklahoma Department of Transportation.
- Mohammad, L.N., Puppala, A.J. and Alavilli, P. (1994). "Influence of Testing Procedure and LVDT Location on Resilient Modulus of Soils." In *Transportation Research Record: Journal of Transportation Research Board*, No. 1462, National Research Council, Washington, D.C., pp. 91–101.
- Mooney, M. A., and N. M. Toohey (2010). "Accelerated Curing and Strength-Modulus Correlation for Lime-Stabilized Soils." Final Report No. CDOT-2010-1A, Research Study Conducted for CDOT by Colorado School of Mines
- Muhanna, A.S., M.S. Rahman, and P.C. Lambe. (1999). "Resilient Modulus Measurement of Fine-Grained Subgrade Soils." In *Transportation Research Record: Journal of Transportation Research Board*, No. 1687, National Research Council, Washington, D.C., pp. 1–12.
- NCHRP Project 1-37A (2004). "Guide for Mechanistic– Empirical Design of New and Rehabilitated Pavement Structures." Final report, Transportation Research Board of the National Academies, Washington, D.C., <http://www.trb.org/mepdg/guide.htm>.

- NCHRP 1-28A (2004). "Laboratory Determination of Resilient Modulus for Flexible Pavement Design." Digest No. 285, 2004, pp. 1–52.
- Osinubi, K.J., and C.M.O. Nwaiwu (2006). "Compaction Delay Effects on Properties of Lime-Treated Soil." *Journal of Materials in Civil Engineering*, Vol. 19, No.2, pp. 250-258.
- Osinubi, K.J., Soni, E.J. and Ijimdiya, T.S. (2010). "Lime and Slag Admixture Improvement of Tropical Black Clay Road Foundation." Proceedings of 89th Meeting of Transportation Research Board (CD-ROM), Washington, D.C.
- Parsons, R.L. and Milburn, J.P. (2003). "Engineering Behavior of Stabilized Soils." Transportation Research Record: Journal of Transportation Research Board, Volume 1837, pp. 20-29.
- Parsons, R.L. and Kneebone, E. (2004). "Use of Cement-Kiln Dust for the Stabilization of Soils." Proceedings of Geo-Trans, Los Angeles, CA, No. 1, pp. 1124-1131.
- Petry, T.M. and Little, D.N. (2002). "Review of stabilization of clays and expansive soils in pavements and lightly loaded structures – history, practice and future." *Journal of Materials in Civil Engineering*, Vol.14, No. 6, pp. 447-460.
- Petry, T. M. and Jiang, C. P. (2007). "Soil Suction and Behavior of Chemically Treated Clays." In *Transportation Research Record: Journal of Transportation Research Board*, No. 2026, National Research Council, Washington, D.C., pp. 30–38.
- Prusinski, J.R. and S. Bhattacharia (1999). "Effectiveness of Portland cement and Lime in Stabilizing Clay Soils." In *Transportation Research Record: Journal of Transportation Research Board*, No.1632, National Research Council, Washington, D.C., 1999, pp.215–227.
- Puppala, A.J. (2008). "Estimating Stiffness of Subgrade and Unbound Materials for Pavement Design." National Cooperative Highway Research Program Synthesis 382.

- Qubain, B.S., E.J. Seksinsky and J. Li. (2000). "Incorporating Subgrade Lime Stabilization into Pavement Design." In *Transportation Research Record: Journal of Transportation Research Board, No. 1721*, National Research Council, Washington, D.C., pp. 3–8.
- Thadkamalla, G. B., and George, K. P. (1995). "Characterization of Subgrade Soils at Simulated Field Moisture." In *Transportation Research Record: Journal of Transportation Research Board, No. 1481*, National Research Council, Washington, D.C., pp. 21–27.
- Thompson, M.R. and Dempsey, B.J. (1969). "Autogenous Healing of Lime-Soil Mixtures." *Highway Research Record*, Vol. 263, pp. 1-7.
- Thompson, M.R. (1970). "Suggested Method of Mixture Design Procedures for Lime-Treated Soils." ASTM Special Technical Publication No. 479.
- Thompson, M.R., and Q.L Robnett. (1979). "Resilient Properties of Subgrade Soils." *Journal of Transportation Engineering*, Vol. 105, No.1.
- Titi, H. H., Elias, M. B., and Helwany S. (2006). "Determination of Typical Resilient Modulus Values for Selected Soils in Wisconsin." University of Wisconsin-Milwaukee, Office of Research Services and Administration, Mitchell Hall, Room 273, Milwaukee, WI.
- Transportation Research Board (1987). "State-of-the-Art Report No. 5," Washington, D.C.
- Seed, H., Chan, C. and Lee, C. (1962). "Resilient Modulus of Subgrade Soils and Their Relation to Fatigue Failures in Asphalt Pavements." *Proceedings of International Conference on the Structural Design of Asphalt Pavements*, Michigan, pp. 611-636.
- Shihata, S.A. and Baghdadi, Z.A. (2001). "Simplified Method to Assess Freeze-Thaw Durability of Soil-Cement." *Journal of Materials in Civil Engineering*, Vol. 13, No. 4, pp. 243-247.

- Simonsen, E. and Isacsson, U. (2001). "Soil Behavior During Freezing and Thawing Using Variable and Constant Confining Pressure Triaxial Tests." *Canadian Geotechnical Journal*, Vol. 38, No. 4, pp. 863-875.
- Solanki, P., Khoury, N. N. and Zaman, M. M. (2009). "Engineering Properties of Stabilized Subgrade Soils for Implementation of the AASHTO 2002 Pavement Design Guide." Final Report FHWA-OK-08-10, 2009, pp. 1–131.
- Solanki, P., Zaman, M.M. and Khalife, R. (2013). "Effect of Freeze-Thaw Cycles on Performance of Stabilized Subgrade." Proceedings for Geo-Congress - Sound Geotechnical Research to Practice: Honoring Robert D. Holtz II, Geotechnical Special Publication, No. 230, pp. 566-580.
- Witczak, W. M., Qi, X. and Mirza, W. M. (1995). "Use of Non Linear Subgrade Modulus in AASHTO Design Procedure." *Journal of Transportation Engineering*, Vol. 121, No. 3.
- Yang, R. R., W. H. Huang, and Y. T. Tai (2005). "Variation of resilient modulus with soil suction for compacted subgrade soils." In *Transportation Research Record: Journal of Transportation Research Board*, No. 1913, National Research Council, Washington, D.C., pp. 99–106.
- Yang, S. R., Lin, H. D., Kung, J. H. S. and Huang, W. H. (2008). "Suction-Controlled Laboratory Test on Resilient Modulus of Unsaturated Compacted Subgrade Soils." *Journal of Geotechnical and Geoenviron. Engineering*, Vol. 134, No. 9, pp. 1375–1384.
- Uzan, J. (1998). "Characterization of Clayey Subgrade Materials for Mechanistic Design of Flexible Pavements." In *Transportation Research Record: Journal of Transportation Research Board*, No. 1629, National Research Council, Washington, D.C., pp. 189–196.

APPENDIX

TABLE A.1 Test results for untreated A-6 subgrade soils.

Cell Pressure (psi)	Deviator stress (psi)	Dry state				Optimum state				Wet state			
		Sample 1	Sample 2	Sample 3	Average Mr (ksi)	Sample 1	Sample 2	Sample 3	Average Mr (ksi)	Sample 1	Sample 2	Sample 3	Average Mr (ksi)
		Mr (ksi)	Mr (ksi)	Mr (ksi)		Mr (ksi)	Mr (ksi)	Mr (ksi)		Mr (ksi)	Mr (ksi)	Mr (ksi)	
6	2	208	216	227	217	150	134	145	143	84	61	68	71
6	4	190	211	219	207	132	129	122	128	80	56	61	66
6	6	177	200	213	197	113	114	109	112	75	51	55	60
6	8	169	195	194	186	104	101	98	101	71	46	50	56
6	10	161	189	173	174	97	91	89	92	67	44	46	52
4	2	221	203	223	216	152	133	150	145	84	61	69	71
4	4	205	213	210	209	134	124	128	129	79	53	59	64
4	6	186	211	203	200	114	120	112	115	75	48	51	58
4	8	177	200	189	189	106	109	99	105	71	45	46	54
4	10	166	191	175	178	100	94	91	95	67	42	39	50
2	2	218	204	222	215	143	130	149	141	83	59	66	70
2	4	203	213	212	210	140	129	126	132	79	53	58	63
2	6	192	208	203	201	119	119	109	116	75	47	50	57
2	8	180	201	187	189	109	104	99	104	71	44	43	52
2	10	172	192	170	178	102	89	90	94	67	41	37	48
0	2	219	208	219	216	148	133	151	144	86	61	69	72
0	4	214	203	211	209	143	123	132	133	83	57	60	66
0	6	209	195	199	201	130	120	111	120	78	50	53	60
0	8	200	186	186	191	123	105	97	108	73	43	47	55
0	10	193	177	173	181	121	93	92	102	69	39	41	50
UCS (psi)		198	184	178	187	135	144	121	133	69	59	64	64
Post UCS MC (%)		13.7	13.3	13.5	13.5	15.7	15.6	15.2	15.5	17.4	17.8	18	17.7

TABLE A.2 Test results for untreated A-7-6 subgrade soils.

Cell Pressure (psi)	Deviator stress (psi)	Max Cyclic Stress (psi)	Dry state			Optimum state			Wet state		
			Sample 1	Sample 2	Average Mr (ksi)	Sample 1	Sample 2	Average Mr (ksi)	Sample 1	Sample 2	Average Mr (ksi)
			Mr (ksi)	Mr (ksi)		Mr (ksi)	Mr (ksi)		Mr (ksi)		
6	2	1.8	156	143	150	98	107	103	59	70	64
6	4	3.6	152	137	144	95	103	99	53	61	57
6	6	5.4	146	134	140	80	91	85	48	51	49
6	8	7.2	141	130	136	76	83	79	43	46	45
6	10	9	136	122	129	74	76	75	40	40	40
4	2	1.8	159	147	153	93	104	99	59	71	65
4	4	3.6	150	137	144	88	96	92	52	64	58
4	6	5.4	144	133	138	80	84	82	47	53	50
4	8	7.2	139	129	134	77	80	79	43	48	45
4	10	9	136	119	128	75	77	76	40	41	40
2	2	1.8	160	145	153	92	103	97	59	69	64
2	4	3.6	150	139	145	91	100	96	52	61	56
2	6	5.4	144	134	139	81	89	85	47	52	50
2	8	7.2	140	127	133	79	85	82	43	44	44
2	10	9	137	120	128	76	79	78	40	38	39
0	2	1.8	163	150	156	105	107	106	61	70	66
0	4	3.6	156	142	149	98	104	101	55	62	58
0	6	5.4	150	133	142	90	91	91	50	54	52
0	8	7.2	144	124	134	83	86	85	46	47	47
0	10	9	139	118	129	78	80	79	43	43	43
UCS (psi)			124	128	126	109	117	113	69	76	73
Post UCS MC (%)			12.7	13.2	13	15	15.2	15.1	17.5	17.1	17.3

TABLE A.3 Test results for A-6 soil with 5% lime (for different sample size at optimum moisture content).

Deviator Stress (psi)	Max Cyclic Stress (psi)	Sample Size: 2.8" x 5.6"				Sample Size: 4" x 8"			
		Sample 1	Sample 2	Sample 3	Average	Sample 1	Sample 2	Sample 3	Average
		Mr (ksi)	Mr (ksi)	Mr (ksi)	Mr (ksi)	Mr (ksi)	Mr (ksi)	Mr (ksi)	Mr (ksi)
10	9	714	787	643	715	721	704	721	713
15	13.5	681	743	631	685	659	673	692	666
20	18	640	711	608	653	591	631	645	611
25	22.5	617	678	592	629	538	591	616	564
30	27	584	649	581	605	486	541	587	514
40	36	540	580	561	560	444	513	538	479
50	45	438	512	505	485	414	482	494	448
UCS (psi)		382	372	421	392	446	448	483	459

TABLE A.4 Test results for A-6 soil with 5% lime (for different moisture state on 4 inch sample).

Deviator Stress (psi)	Dry state			Optimum state			Wet state		
	Sample 1	Sample 2	Average Mr (ksi)	Sample 1	Sample 2	Average Mr (ksi)	Sample 1	Sample 2	Average Mr (ksi)
	Mr (ksi)	Mr (ksi)		Mr (ksi)	Mr (ksi)		Mr (ksi)	Mr (ksi)	
10	905	932	918	704	721	713	534	499	516
15	949	998	974	673	692	682	519	481	500
20	994	1031	1012	631	645	638	494	462	478
25	1031	1014	1023	591	616	603	467	429	448
30	1061	1094	1077	541	587	564	452	411	432
40	1116	1087	1102	513	538	525	437	380	409
50	1159	1220	1189	482	494	488	414	357	385
UCS (psi)	557	598	578	448	483	466	404	338	371
MC (%)	15.7	15.4	15.6	17.5	17.6	17.6	20	19.4	19.7

TABLE A.5 Test results for A-6 soil with 7% lime (for different sample size at optimum moisture content).

Deviator Stress (psi)	Max Cyclic Stress (psi)	Sample Size: 2.8" x 5.6"				Sample Size: 4" x 8"			
		Sample 1	Sample 2	Sample 3	Average	Sample 1	Sample 2	Sample 3	Average
		Mr (ksi)	Mr (ksi)	Mr (ksi)	Mr (ksi)	Mr (ksi)	Mr (ksi)	Mr (ksi)	Mr (ksi)
10	9	990	1182	1193	1122	1138	1045	1116	1092
15	13.5	985	1133	1146	1088	1051	981	1066	1016
20	18	977	1091	1104	1057	994	939	1025	966
25	22.5	912	1054	1077	1014	929	881	980	905
30	27	867	1025	1042	978	883	857	927	870
40	36	830	960	978	923	855	827	883	841
50	45	813	891	940	881	812	792	840	802
UCS (psi)		571	648	645	621	717	583	618	639

TABLE A.6 Test results for A-6 soil with 7% lime (for different moisture state on 4 inch sample).

Deviator Stress (psi)	Dry state			Optimum state			Wet state		
	Sample 1	Sample 2	Average Mr (ksi)	Sample 1	Sample 2	Average Mr (ksi)	Sample 1	Sample 2	Average Mr (ksi)
	Mr (ksi)	Mr (ksi)		Mr (ksi)	Mr (ksi)		Mr (ksi)	Mr (ksi)	
10	1329	1410	1370	1045	1116	1081	869	824	846
15	1342	1442	1392	981	1066	1024	798	773	785
20	1375	1485	1430	939	1025	982	754	732	743
25	1401	1504	1452	881	980	930	745	685	715
30	1425	1545	1485	857	927	892	710	662	686
40	1476	1609	1543	827	883	855	649	610	630
50	1507	1642	1574	792	840	816	584	575	579
UCS (psi)	698	686	692	618	583	601	541	482	512
Post UCS MC (%)	16	16.4	16.2	18.5	18.5	18.5	20.6	20.3	20.5

TABLE A.7 Test results for A-7-6 soil with 5% lime (for different sample size at optimum moisture content).

Deviator Stress (psi)	Max Cyclic Stress (psi)	Sample Size: 2.8" x 5.6"				Sample Size: 4" x 8"		
		Sample 1	Sample 2	Sample 3	Average Mr (ksi)	Sample 1	Sample 2	Average Mr (ksi)
		Mr (ksi)	Mr (ksi)	Mr (ksi)		Mr (ksi)	Mr (ksi)	
10	9	848	861	851	853	880	858	869
15	13.5	786	775	809	790	837	811	824
20	18	699	711	768	726	773	798	785
25	22.5	667	682	750	700	754	701	727
30	27	642	649	734	675	706	643	675
40	36	589	580	698	622	661	629	645
50	45	561	512	622	565	604	582	593
UCS (psi)		402	361	421	395	446	421	434

TABLE A.8 Test results for A-7-6 soil with 5% lime (for different moisture state on 4 inch sample).

Deviator Stress (psi)	Dry state			Optimum state			Wet state		
	Sample 1	Sample 2	Average Mr (ksi)	Sample 1	Sample 2	Average Mr (ksi)	Sample 1	Sample 2	Average Mr (ksi)
	Mr (ksi)	Mr (ksi)		Mr (ksi)	Mr (ksi)		Mr (ksi)	Mr (ksi)	
10	1227	1313	1270	880	858	869	509	494	501
15	1214	1310	1262	837	811	824	467	468	468
20	1196	1299	1248	773	798	785	418	422	420
25	1182	1289	1235	754	701	727	375	371	373
30	1173	1288	1230	706	643	675	341	332	336
40	1148	1263	1205	661	629	645	293	284	289
50	1121	1236	1179	604	582	593	267	255	261
UCS (psi)	531	549	540	446	421	434	351	338	345
Post UCS MC (%)	14.2	14.8	14.6	16.3	16.5	16.4	19.8	19.2	19.5

TABLE A.9 Test results for A-7-6 soil with 7% lime (for different sample size at optimum moisture content).

Deviator Stress (psi)	Max Cyclic Stress (psi)	Sample Size: 2.8" x 5.6"				Sample Size: 4" x 8"		
		Sample 1	Sample 2	Sample 3	Average Mr (ksi)	Sample 1	Sample 2	Average Mr (ksi)
		Mr (ksi)	Mr (ksi)	Mr (ksi)		Mr (ksi)	Mr (ksi)	
10	9	457	568	401	475	521	500	511
15	13.5	419	504	382	435	485	494	490
20	18	381	453	343	392	472	482	477
25	22.5	368	421	328	372	460	468	464
30	27	353	397	310	353	453	441	447
40	36	337	370	291	333	434	421	427
50	45	284	332	274	297	415	387	401
UCS (psi)		389	294	367	350	374	353	364

TABLE A.10 Test results for A-7-6 soil with 7% lime (for different moisture state on 4 inch sample).

Deviator Stress (psi)	Max Cyclic Stress (psi)	Dry state			Optimum state			Wet state		
		Sample 1	Sample 2	Average	Sample 1	Sample 2	Average	Sample 1	Sample 2	Average
		Mr (ksi)	Mr (ksi)	Mr (ksi)	Mr (ksi)	Mr (ksi)	Mr (ksi)	Mr (ksi)	Mr (ksi)	Mr (ksi)
10	9	684	720	702	521	500	511	378	397	387
15	13.5	640	675	657	485	494	490	366	383	375
20	18	621	649	635	472	482	477	346	375	361
25	22.5	608	634	621	460	468	464	340	360	350
30	27	603	628	616	453	441	447	333	355	344
40	36	589	602	596	434	421	427	319	347	333
50	45	587	588	587	415	387	401	307	335	321
UCS (psi)		419	452	436	374	353	364	292	315	304
Post UCS MC (%)		15	15.5	15.3	17.7	17.6	17.7	20.1	19.5	19.8